

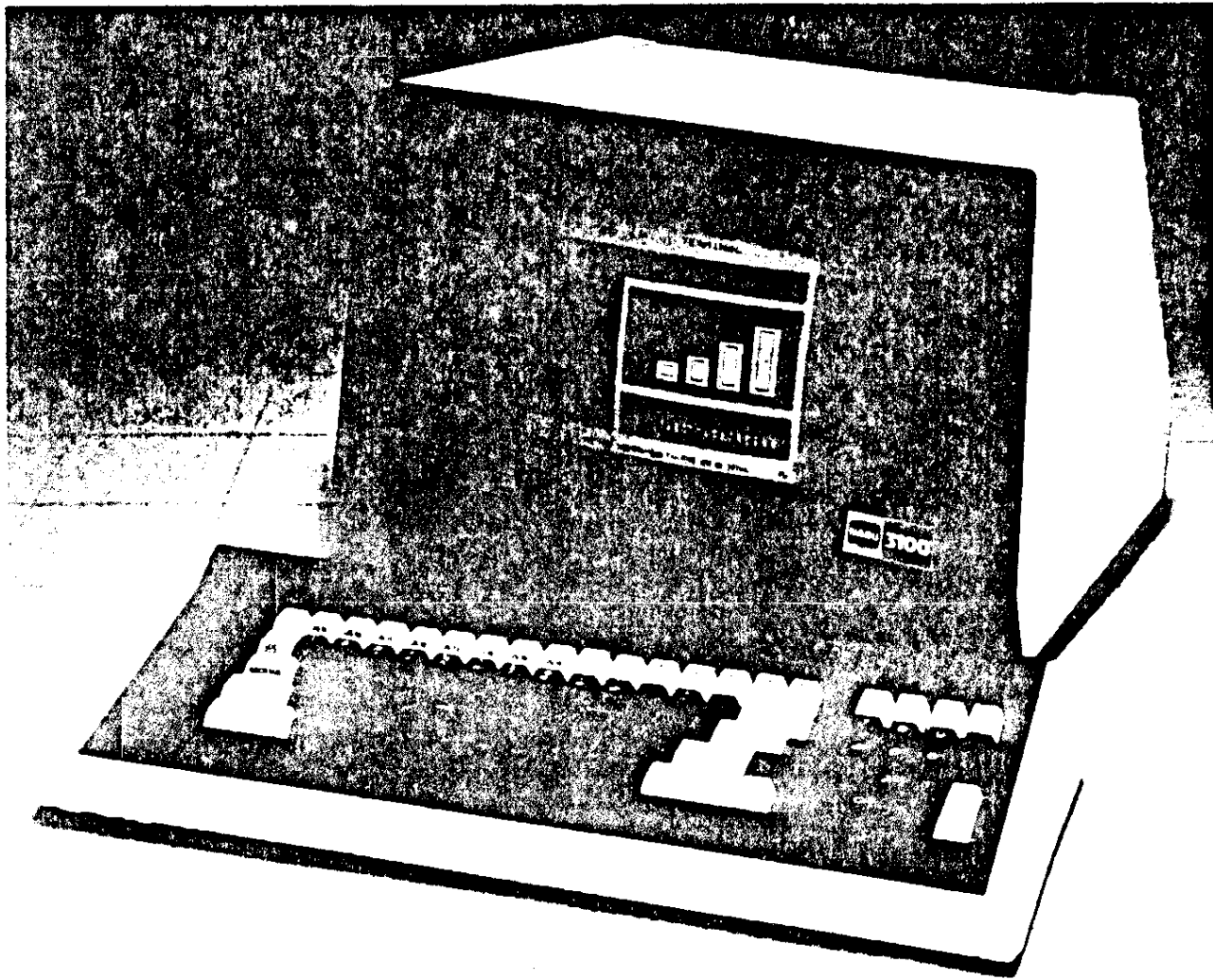

**COMMERCIAL
TERMINALS**
Formerly Volker, Craig

NABU 3100 Users Manual

NABU 3100 Users Manual



COMMERCIAL TERMINALS

(Formerly Volker-Craig)

NABU MANUFACTURING CORPORATION, COMMERCIAL TERMINALS

Canada and International 330 Weber Street North Waterloo, Ontario, Canada N2J 3H6 • (519) 884-9300 Toronto • (416) 456-2070 Telex: 061155327	United States 333 Metro Park Rochester, New York U.S.A. 14623 • (716) 475-1221	United Kingdom William Olds Estate, Tolpits Lane, Watford Hertfordshire, England WD1 8XL Rickmansworth • (09237) 71378 Telex: 8958082 Northern Office: 58 High Street, Prescott Merseyside L34 6HQ • (051) 430-7002
--	---	--

Distributors in: Argentina, Austria, Australia, Belgium, Canada, Denmark, England, Finland, France, Germany, Greece, Hong Kong, Ireland, Israel, Italy, Japan, Korea, Mexico, The Netherlands, New Zealand, Norway, Philippines, Singapore, Spain, Sweden, Switzerland, Taiwan, U.S.A.

TABLE OF CONTENTS

<p>I GENERAL INFORMATION 1-1</p> <ul style="list-style-type: none"> • Introduction 1-1 • How to Use the Manual 1-1 • Scope and Arrangement 1-1 • Purpose of Terminal 1-1 • Functional Description 1-1 • Standard Features 1-1 • Optional Features 1-4 • Terminal Components 1-4 • • Main Keyboard 1-4 • • Dual-Function Keypad 1-4 • • Video Display Screen 1-4 <p>II HOW TO BEGIN 2-1</p> <ul style="list-style-type: none"> • Initial Inspection 2-1 • Installation 2-1 <p>III USER NOTES 3-1</p> <ul style="list-style-type: none"> • Arrangement 3-1 • Operating Switches and Control 3-1 • • Power On-Off Switch 3-1 • • Dip-Switches 3-1 • Key Functions 3-1 • Operating Procedures 3-4 • • Start-Up 3-4 • • Status Line Access 3-4 • Status Line Display 3-4 • • Status Line Set-Up Mode 3-7 • Character Presentation On Screen 3-17 • • Audible Feedback 3-17 • • Character Set Selection 3-17 • • Character Attributes 3-17 	<ul style="list-style-type: none"> • • Character Width Functions 3-17 • • Screen Background 3-17 • Cursor Control 3-17 • • Page Records 3-21 • • Cursor Position Indicator 3-21 • • Cursor Position Reporting 3-21 • Editing Modes 3-22 • • Block Editing Modes 3-22 • Tab Functions 3-25 • • Tab Function Escape Codes 3-25 • User String (US) Keys 3-25 • Scrolling Region (Split Screen) 3-25 • Screen Alignment Display 3-26 <p>IV PROGRAMMER NOTES 4-1</p> <ul style="list-style-type: none"> • Communication Modes 4-1 • • Operation Modes 4-1 • RS232C Parameters 4-1 • Conversational Control Functions 4-1 • • Transmission Control Codes 4-1 • • Interrogation Codes 4-2 • • Full Duplex (FDX) Mode 4-2 • • Half Duplex (HDX) Mode 4-3 • • Local (LOC) Mode 4-3 • • Block (BLK) Mode 4-4 • • Communication Commands 4-4 <p>Appendix 1 GLOSSARY OF TERMS A1-1</p> <p>Appendix 2 ASCII CODE CHART A2-1</p> <p>INDEX</p>
--	---

LIST OF FIGURES

<p>1-1 Keyboard Layout 1-5</p> <p>2-1 Rear Panel, Video Terminal, 2-2 Input Output Connections</p> <p>3-1 Operating Switches and Controls 3-2</p> <p>3-2 Dip-Switch Settings 3-3</p> <p>3-3 Description of Key Functions 3-5</p> <p>3-4 Status Line Format 3-6</p> <p>3-5 Set-Up Mode 3-7</p> <p>3-6 Application Keypad Mode 3-8</p> <p>3-7 Protected Field Mode 3-10</p> <p>3-8 Edit and Insert Mode 3-11</p>	<p>3-9 Communications Mode 3-12</p> <p>3-10 Graphics Mode 3-13</p> <p>3-11 Monitor Mode 3-13</p> <p>3-12 Receive (RX) and Transmit (TX) Speeds .. 3-16</p> <p>3-13 Status Reset 3-16</p> <p>3-14 ESCape Codes which Define G0 and G1 .. 3-18</p> <p>3-15 Character Attributes 3-18</p> <p>3-16 Cursor Control 3-19</p> <p>3-17 Page and Cursor Position Indicator 3-21</p> <p>3-18 Editing Keys 3-22</p> <p>3-19 Deletion Keys and Sequences 3-24</p> <p>4-1 Communication Commands 4-5</p> <p>4-2 Transmission Delimiter Programming 4-6</p>
--	---

LIST OF TABLES

1-1 NABU3100 Specifications, Interface Cables and Options	1-2
2-1 RS232C Pin Assignments for Host Port	2-1
3-1 Set-Up Parameters	3-7

I. GENERAL INFORMATION

INTRODUCTION

This user's manual describes the features and operations of the NABU3100 video terminal manufactured by Nabu Manufacturing Corporation, Commercial Terminals, Waterloo, Ontario, Canada.

HOW TO USE THE MANUAL

The information is arranged to suit two levels of operators: keyboard users and programmers. A single configuration of the terminal is described including optional hardware and software features.

SCOPE AND ARRANGEMENT

This manual has been prepared for use with the NABU3100 terminal. It is not a course in programming but rather an aid to assist you in rapidly learning how to operate the NABU3100. It covers all functions of the system including: input and editing, programming and data management. It also includes instructions for communications with a host computer and with peripheral devices.

The manual instructions and procedures have been arranged in a logical sequence to facilitate hands-on training. Therefore, they should be studied thoroughly prior to operating the system.

It is assumed that an operator will have a basic knowledge of computer terminals, the terminology and system concepts before attempting to use the manual.

NOTE

A glossary of terminology and abbreviations is appended to this manual.

Nabu Manufacturing Corporation welcomes comments and suggestions on the contents of the manual. Comments should be directed to:

Nabu Manufacturing Corporation,
Commercial Terminals,
330 Weber Street North,
Waterloo, Ontario, Canada
N2J 3H6
Attn: Marketing Department

PURPOSE OF TERMINAL

The NABU3100 is a direct-entry terminal with powerful editing and programming capabilities. It combines the simplicity of a detached secretarial keyboard for input, the efficiency of a video display screen for editing, and

the convenience of local data storage for up to eight pages. It includes a serial, asynchronous, bi-directional, peripheral interface which makes it compatible with most general purpose host computers.

FUNCTIONAL DESCRIPTION

The NABU3100 is a smart editing data terminal which includes a Z-80 microprocessor. Table 1-1 lists the system specifications.

The system is capable of communicating with a host computer in either a full duplex or half duplex mode. The terminal facilitates entering, editing and formatting data for transmission. It also permits data to be received for various applications including editing and formatting.

STANDARD FEATURES

- Keyboard: Detached with serial coiled cable to terminal. Full typewriter layout with separate 14 key numeric pad plus cursor control keys.
- Display: 24 lines (rows) × 80 columns.
- Status line: 25th line, user selectable, user writeable.
- Display background: Grey.
- Split screen: User definable split size.
- Display memory: 1 page (second page optional).
- Scrolling: Keyboard selectable, smooth or jump scroll.
- Display characters: 7 × 9 dot matrix in a 9 × 10 dot field.
- Characters: May be double width on a line basis.
- Character Highlighting: Four different highlights on a character basis. Blink, bold, reverse, underscore.
- Editing: Full editing functions; protected fields.
- User strings: 16 user programmable string keys.
- Escape sequences: ANSI X 3.64 compatible.
- Transmission: Block transmission capability: line, page and partial page.
- Speeds: 15 baud rates up to 9,600. Transmit and receive speeds are selectable independently.
- Power Requirements: 115 or 230 Vac, 60 or 50 Hz.

Terminal Type:			Typewriter style layout.
TTY compatible:	Z-80 microprocessor-based.		Connected with serial coiled cord which extends to four feet. Serial data communications with controller.
Configuration:			
NABU3100:	120 V, 50/60 Hz		
NABU3100/EXP:	240 V, 50/60 Hz		
Communications:			
Code:	ASCII and ANSI X 3.64 compatible escape sequences		
Type:	Serial asynchronous, switchable XON/XOFF or DTR control from local or host.	Keyboard:	96 keys, 26 letter alphabet, upper/lower case, numerals 0 through 9, punctuation, cap lock. Auto repeating (15 characters/second).
Speed:	50, 75, 110, 134.5, 150, 200, 300, 600, 1200, 1800, 2000, 2400, 3600, 4800, 9600; split send/receive speeds.	Numeric keypad:	14 keys, 0 through 9, comma, period, minus, ENTER (double size).
Method:	Character by character in conversational mode or by line, message or page in buffered transmit mode.	Cursor control:	Up, down, left, right, home.
Mode:	Full duplex, half duplex or echoplex.	Functional command keys:	Escape, delete (rubout), break control, line feed, back space, return, tab/backtab, clear, copy, smooth, setup.
Character size:	7 or 8 bit set-up selectable.	Editing keys:	Insert character, delete character, insert line, delete line.
Parity:	Odd/even/none.	User string keys:	16 user programmable string keys, US1-US8 (shift US9-US16); programmable up to 256 character total for all keys.
Interface:	EIA standard RS232C (CCITT V24).	Data Entry:	Bi-directional smooth scroll, bottom line entry. Jump scroll, bottom line entry. Scrolling region, bottom line entry. Screen area outside scrolling region is fixed but modifiable by cursor address commands.
Screen Presentation:			
Display unit:	30 cm (12 inch) non-glare CRT, P4 phosphor. Light or dark background, switch or escape sequence selectable.	Terminal Functions:	
Display format:	24 lines × 80 characters, 1920 characters	Cursor:	Non-destructive, blinking block.
Status line:	25th line indicates current state of the terminal; user or host writeable.	Cursor control functions:	Left, right, up, down, home clear and home, backspace, line feed, direct X-Y cursor addressing using cursor control command.
Character type:	7 × 9 dot matrix in 9 × 10 field, 2 dot descender.	Mode:	All terminal commands and functions are compatible with the American National Standards Institute (ANSI) X3.64 standard for display terminals.
Character generation:	ROM/PROM	Audible alarm:	On receipt of control G (BEL code) from host computer or keyboard.
Refresh Rate:	60 Hz, 50 Hz, switch selectable.		
Refresh memory:	Static RAM		
Character set:	128 ASCII characters, including upper/lower case, 16 line graphics characters and 16 national character set symbols.		
Keyboard Functions:			
Type:	Detached, 8048 microprocessor based.		

Table 1-1 NABU3100 Specifications, Interface Cables and Options

Operator Controls:		Power:	
Front Panel:	Power Off/On, Display Contrast, Setup Mode used to provide: terminal reset, establish normal or alternate keypad mode, protected or non-protected mode, edit modes (edit line, edit page, insert line or insert page), communications mode (local, block, half duplex, full duplex, echoplex); alternate character set, normal or monitor mode; transmit and receive baud rates to and from host computer, serial peripheral interface baud rate.	Standard: 100/120 ± 10 Vac, 50/60 Hz	Optional: 200/240 ± 20 Vac, 50/60 Hz
Back panel:	4 user accessible DIP switch banks (8 switches per bank). (switch bank 1) transmit and receive baud rates; (Switch bank 2) refresh frequency 50/60 Hz, operation mode, 2 stop bits, word length, parity; (switch bank 3) national character set, light or dark screen background, key click, DTR control, XON/XOFF control; (switch bank 4) serial peripheral port baud rate, DTR control, XON/XOFF control.	Overload protection:	Primary is fused 1 A fast blow (dual 0.6 A fast blow with 240 V option)
Indicators:		Environmental:	(operating)
Status Line:	Indicates: set-up mode, protected mode, edit mode, transmission mode, graphics mode, page, row and column co-ordinates of cursor, transmit and receive baud rates to and from host, monitor mode, alternate keypad mode, serial peripheral port mode, serial peripheral port baud rate, firmware version.	10°C to 40°C, 8% to 80% relative humidity (no condensation allowed). Maximum wet bulb 28°C.	Physical:
		NABU3100:	51.5 cm W × 55.5 cm D × 34.0 cm H, 16.5 kg
		NABU3100/RO:	42.0 cm W × 37.5 cm D × 34.0 cm H, 13.3 kg
		Keyboard (KB3100):	51.5 cm W × 22.5 cm D × 8.5 cm H, 3.2 kg
		Interface Cables:	
		CE01-2M:	RS232C (CCITT-V.24) terminal to data set cable.
		CI04-2M:	20 mA, current loop adapter cable.
		RS449/H:	Adapter host port (RS423 compatible)
		RS449/P:	Adapter peripheral port (RS423 compatible)
		Options:	
		Option SPI:	Buffered bi-direction serial peripheral interface.
		Option CDS:	Colored anti-glare display screen
		Option NCS:	(Specify: amber or P31 green)
		Option MEM:	Additional page of memory
		Option MEM:	Additional page of memory

Table 1-1 NABU3100 Specifications, Interface Cables and Options (Cont)

OPTIONAL FEATURES

- Composite video output.
- Background: Green or amber.
- Display memory: second page.
- National character set.
- Output: Bi-directional, buffered serial peripheral port.

TERMINAL COMPONENTS

The NABU3100 has two principal components: A detached keyboard and a video terminal.

The detached keyboard is used to input data and instructions into the terminal. The keyboard contains a main keyboard and a dual-function keypad. See Figure 1-1. The keyboard includes an integral coiled cable which interconnects with the video terminal through a quick-release plug and socket immediately below the screen.

The video terminal screen, displays the data and instructions entered from the keyboard and host computer.

Main Keyboard

The main keyboard has a standard QWERTY typewriter arrangement, which has been expanded to include additional characters. Also on the main keyboard are all cursor positioning keys, status line controls, scroll features, tabs and programming keys.

Dual-Function Keypad

The keypad on the right hand side has 18 keys. The top row of keys are for editing; the remainder are numeric and punctuation keys and a double-width ENTER key. When the AK (application keypad) mode has been set up, these keys provide a second level function. The

numerics and punctuation keys are duplicates of the same keys in the main keyboard.

Video Display Screen

Capacity. The 30 cm (12 inch) non-glare screen has a display capacity of 1920 characters in 24 rows, 80 characters per row. This is followed by a status line across the 25th row of the screen.

Character Definition. As characters and instructions are typed into the screen, they are displayed in approximately 14 point type with a 7×9 dot matrix character resolution.



Character Highlights. The screen is provided with either white, green or amber characters. In addition, the characters can be highlighted in four different ways by blinking, reverse (black in colour), underlining and bold face.

Scrolling. The screen text or portions of text may be scrolled up or down, however, there is no additional buffer memory, therefore text which leaves the top or bottom of the screen cannot be recovered on the screen.

Cursor. The cursor is a blinking box that indicates the position on the screen. The cursor travels along a line as the operator types and indicates the position where the next keystroke will appear. When the cursor reaches the end of the line, it stops at the 80th column. The



key moves the cursor back to column 1 on

the same line. The  key or  key advances the cursor to the next line.

Status Line. The status line displays the operational mode and parameters in fourteen different fields. The first field is reserved for the SET-UP descriptor which blinks (normal/ reverse) when the 'change status' mode is entered.

MAIN KEYBOARD

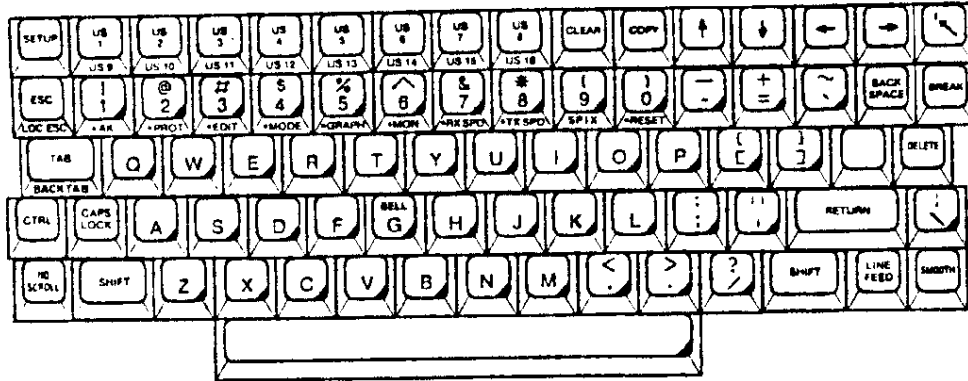

KEY PAD

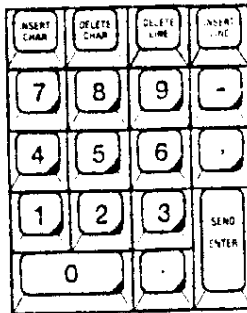

Legend

- White key with black lettering
- Black key with white lettering
- Denotes yellow lettering on key

Figure 1-1 Keyboard Layout

II. HOW TO BEGIN

INITIAL INSPECTION

The keyboard, video display and standard interface cables are packaged for transportation in a single cardboard carton.

When a package is received, carry out the following procedure:

1. Store the shipment indoors.
2. Open the carton. Verify that the contents are complete, in accordance with the package list.
3. Inspect the terminal for physical damage. Inspect the switches, connectors and video screen.

NOTE

The original shipping carton and package materials should be kept for possible future shipping of the terminal.

4. Claim for Damage. If physical damage is evident, report it to the carrier. If the terminal does not operate correctly when received, notify the nearest Nabu sales/service immediately. Arrangements will be made for repair or replacement of the terminal.

INSTALLATION

The NABU3100 can be installed in virtually any configuration and location. Its portability facilitates being moved from one location to another whenever user requirements change. An acoustic coupler can be plugged in directly for use with a telephone.

All cable connections, except for the keyboard, are made at the rear of the terminal. See Figure 2-1. Make the following interconnections:

1. Insert the quick-release plug on the end of the coiled keyboard cable into the connector located below the video screen.
2. Connect the a-c power cord to the extreme right-hand connector on the rear of the terminal. Connect to the appropriate a-c power source:

North America: 120 \pm 10 Vac, 60 Hz.
Export Model: 240 \pm 20 Vac, 50 Hz.

CAUTION

Set the frequency dip-switch (S2-1) to the line frequency, either 60 Hz (down) or 50 Hz (up), before turning on the system power switch.

3. Connect a cable with an RS232C (CCITT V.24) 25-pin connector from the host computer, multiplexer or external modem, to the SERIAL DATA connector on the extreme left of the rear of the terminal. The pin assignments are listed in Table 2-1.

Pin No.	Signal Description
1	Chassis ground
2*	Transmit (TX) data output
3*	Receive (RX) data input
4	Request to send (RTS) (Turned on before data is sent)
5	Clear to send (CTS) input (May be turned off to prevent transmission)
6	Data Set Ready (DSR) input
7*	Signal ground (connected internally to pin 1)
8	Carrier detect input
9	Not used
10	Not used
11	Supervisory transmit (SUP TX) output
12	Not used
13	Not used
14	Reserved for power output to external adapters (+ 12V)
15	Not used
16	Not used
17	Not used
18	Reserved for power output to external adapters (- 12V)
19	Connected internally to pin 11
20	Data terminal ready (DTR) output (May be used to squelch the host computer)
21	Not used
22	Not used
23	Connected internally to pin 11
24	Not used
25	Reserved for power output to external adapters

NOTE

Pins 2*, 3* and 7* are the minimum connections required to be connected to the host computer. Unused pins must remain open circuit.

The female connector on the rear of the terminal carries live RS232C voltage levels.

CAUTION

Be careful not to short any of the pins on the connector together or to ground because it could result in damage to the terminal.

Table 2-1 RS232C Pin Assignments for Host Port

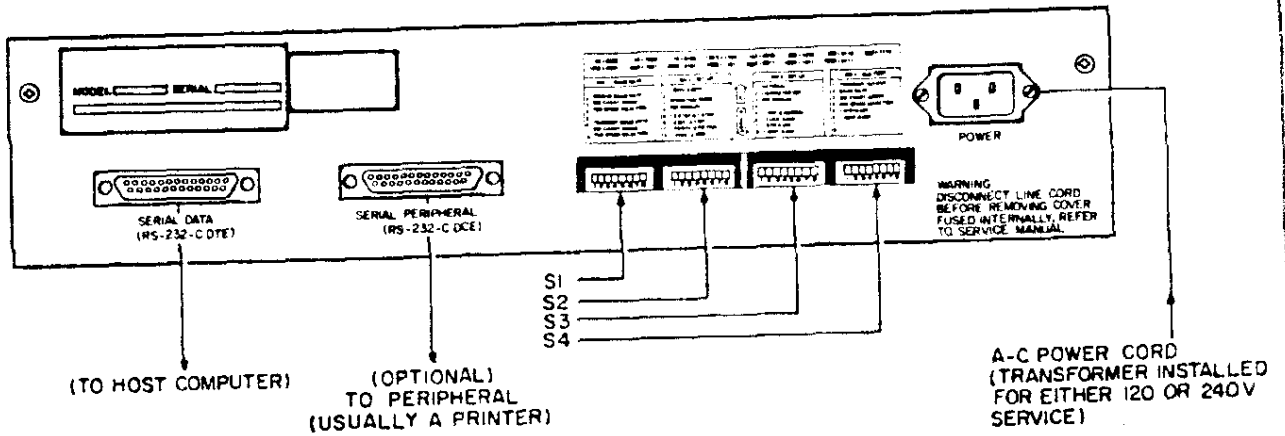

PART NO. MARKETING/INVENTORY	DESCRIPTION
CE01-2M 79-900-00001	25-pin male D connector on each end. Two metres long. (Used for terminal to host computer or terminal to printer.)
CE01-12M 79-900-00002	Same as CE01-2M except twelve metres long.
CE02-2M	Same as CE01-2M except one end has pins 2 and 3 reversed. (Used for terminal to terminal cable.)

Figure 2-1 Rear Panel, Video Terminal, Input Output Connections



ARRANGEMENT

This chapter provides information, instructions and recommended procedures for terminal users. It also applies to programmers who are responsible for the software interface with a host computer. The information is arranged as follows:

1. **Operating Switches and Control**
 - Power on/off switch
 - Dip-switches
2. **Key Functions**
3. **Operating Procedures**

NOTE

In the text the following symbology is used: For example:

1.  indicates that the keys are pressed in sequence.
2.  indicates that the keys are pressed simultaneously.

OPERATING SWITCHES AND CONTROL

Power On-Off Switch

This is a dual control located on the left edge of the screen. The rotary switch controls the power to the system. The rotary control varies the contrast of the display. See (1) Figure 3-1.

Dip-switches

The NABU3100 has four switch banks located at the back of the terminal. See (2) Figure 3-1. Each switch bank contains eight dip-switches, numbered from 1 to 8, for a total of thirty-two user accessible switches. These switches set up the required baseline operating parameters.

The dip-switches can be used to set the baud rates, edit mode, operating mode, stop bits, word length, parity, National character set, frequency, screen background, key click, DTR control, XON/XOFF control and auxiliary port operation. Refer to Figure 3-2 for a description of the dip-switch selections.

Dip-switch settings are sensed only at:

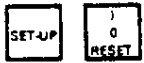
1. Power up and
2. Reset (ie, depressing )

Any change in dip-switch selections must be followed by a power up or a reset so that the change will be sensed.

Most dip-switch selections may also be changed using keyboard entries while in the set-up mode or by using escape sequences. These changes, entered from the keyboard are volatile, therefore they override the associated dip-switch selections until the power is disconnected or the system is reset. The selection then defaults to the dip-switch settings.

KEY FUNCTIONS (See Figure 3-3)

The keyboard and keypad contain the following:

1. **Alphanumeric keys.**
 - 26 upper case (shifted) and lower case (unshifted) alphabetical keys arranged in the qwerty format.
 - 10 numeric keys in lower case position.
 - 32 pi characters.
 - A SHIFT key to access upper case letters and pi characters when pressed simultaneously.
 - A CAPS LOCK key which sets the alpha keys only to the shifted position. The key is released by pressing a second time.

NOTE

The SHIFT and CAPS LOCK keys do not function in the keypad. Furthermore, these keys do not produce a code. They merely modify the code of the associated alphanumeric or pi character.

- A calculator type keypad with numerics and punctuation.

2. **Screen Format keys.**

- A TAB key which moves the cursor to the right without deleting characters, either to a set tab or to column 80 if no tabs are set.
- A BACKTAB key (ie, SHIFT, TAB) which moves the cursor to the previous set tab or to column 01 on the same line if no tabs are set.
- A RETURN key which moves the cursor directly to column 01 on the same line.
- A LINE FEED key which advances the cursor to the next row.

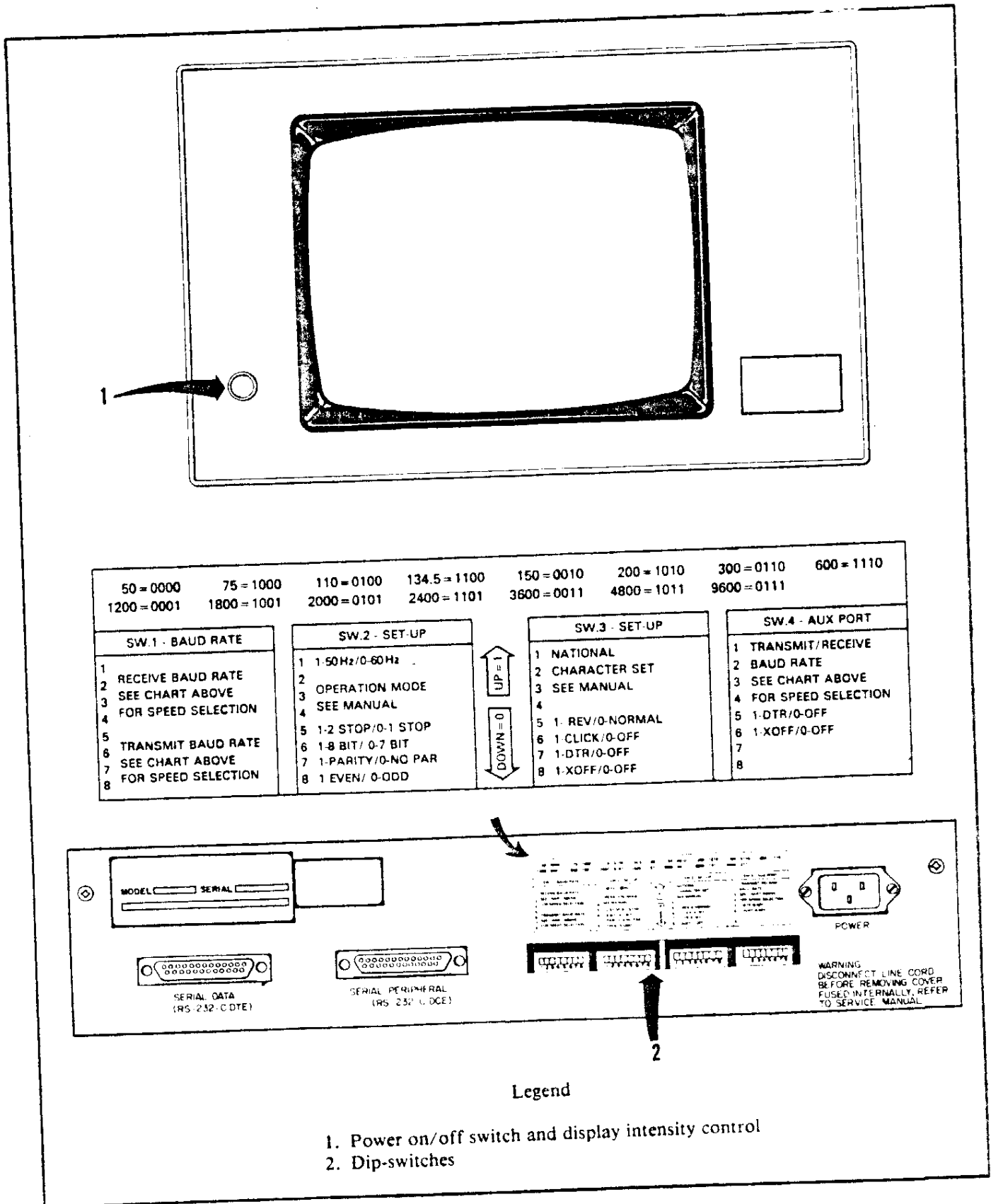
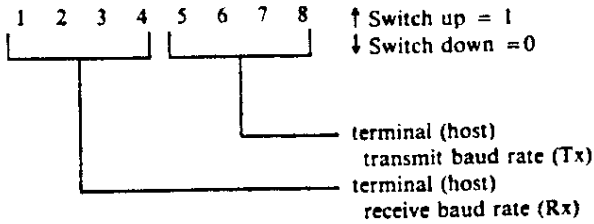

Figure 3-1 Operating Switches and Controls

S1: BAUD RATES



PATTERN	BAUD RATE
1234 (Rx)	
5678 (Tx)	
0000	50
1000	75
0100	110
1100	134.5
0010	150
1010	200
0110	300
1110	600
0001	1200
1001	1800
0101	2000
1101	2400
0011	3600
1011	4800
0111	9600

S3: SET-UP

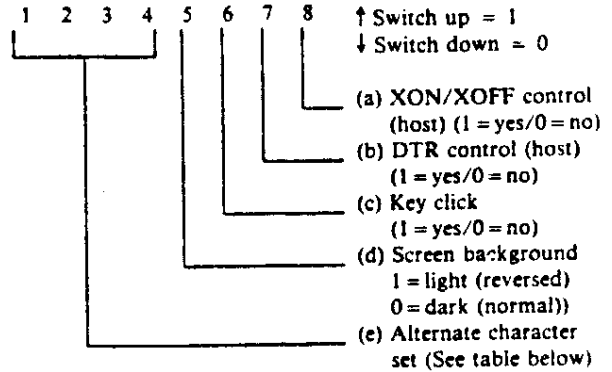

PATTERN	LANGUAGE CHARACTER SET
1234	
0000	Disabled
0001	AZERTY French
0010	CSA French
0011	Danish/Norwegian
0100	German
0101	Italian
0110	Norwegian Names
0111	Spanish
1000	Swedish/Finnish
1001	Swedish Names
1010	Swiss/German

S2: SET-UP

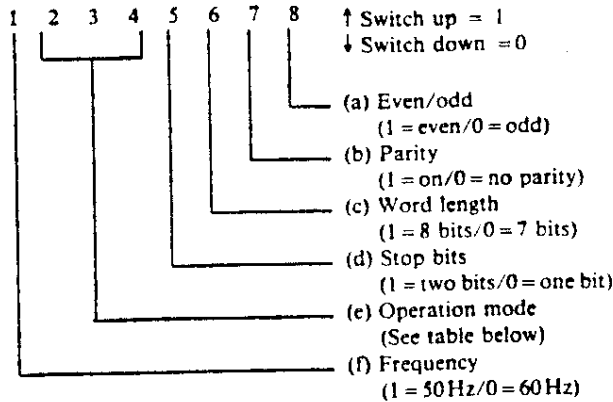

PATTERN	SELECTION
234	
000	Local (LOC)
010	Block (BLK)
001	Full Duplex (FDX)
011	Local Echo (ECH)
100	CR turnaround code
110	EOT turnaround code
111	ETX turnaround code

} Half Duplex

S4: AUX PORT

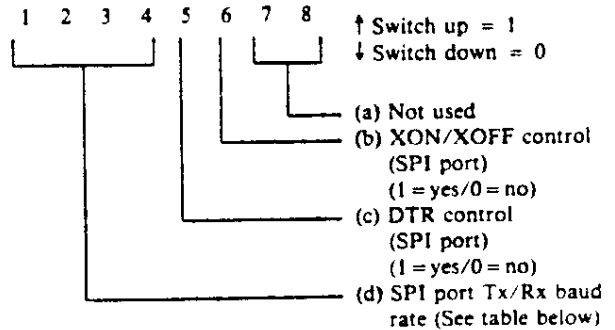

PATTERN	BAUD RATE
1234	
0000	50
1000	75
0100	110
1100	134.5
0010	150
1010	200
0110	300
1110	600
0001	1200
1001	1800
0101	2000
1101	2400
0011	3600
1011	4800
0111	9600

Figure 3-2 Dip-Switch Settings

3. Status line keys.

- The SET-UP key which activates the parameters and functions identified in yellow on keys 1 through 8 and 0.
- Nine parameter and function keys (1 through 8 and 0).

4. User Strings.

- Eight keys with unshifted (US1 through US8) and shifted (US9 through US16) positions to provide 16 programmable user strings.

5. User Command keys.

- The ESCape key which prefixes commands to the display; host computer and peripherals.
- The LOC ESC key (ie, SHIFT-ESC) which acts upon the sequence command within the terminal but inhibits transmission of that escape sequence to the host.
- The CTRL (control) key which is used in conjunction with control sequences.
- The BREAK key which causes the terminal to set the data transmission line to a space condition during the period that the BREAK key is pressed. (Caution: This key might cause a disconnect from the host in certain interfaces).
- The COPY key which is used in conjunction with the SPI.
- The SEND-ENTER key. The ENTER key functions in the same manner as the RETURN key.

6. Editing keys.

- Five cursor positioning keys identified by arrows.
- A BACK SPACE key which moves the cursor to the left without deleting characters.
- Four insert/delete keys.
- A screen CLEAR key.
- The DELETE key which operates in the conversational mode. This key transmits a delete character code to the host computer. As a result, a character may or may not be erased from the screen.
- The NO SCROLL and SMOOTH scroll keys.

NOTE

There is also one unassigned key for future expansion. The G key is also the bell key.

OPERATING PROCEDURES

START-UP. Proceed as follows:

1. Set up the system, terminal, peripherals and interface with the host computer as described in Chapter II.

2. Set the dip-switches to the required initial or default positions.

3. Rotate the power on/off switch to energize the terminal, then adjust the control to give the desired screen contrast.

STATUS LINE ACCESS

Access to the status line is controlled by the ESCape code:

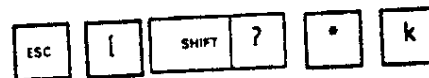

When * = 8 the status line is deleted.

= 9 the status line is controlled by the user therefore the SET-UP parameters are not updated on the screen.

= 10 the status line is on.

= 11 the status line is controlled by the terminal (ie, set-up parameters are updated on the screen).

STATUS LINE DISPLAY

When power is turned on, the status line appears across the 25th row on the screen. The status line entries shown in the upper diagram, Figure 3-4, are typically those which would appear at power on or following reset. The entries are based on the settings of the dip-switches on the rear of the unit or the cursor position in the case of the R= and C= values.

The status line displays the current state of the terminal options. The status line is normally displayed with the background opposite to the rest of the screen, (ie, a black background if the other twenty-four lines are set for a colour, and vice versa). The complete format for the status line is shown in the lower diagram, Figure 3-4. The * items relate to the dip-switch settings and reset (default). The fields (columns) assigned to the various descriptors are given in parentheses () below the status line.

The status line entries may be changed by keyboard entries using the SET-UP key. The status line may also be deleted to provide a 25th row for data entry.

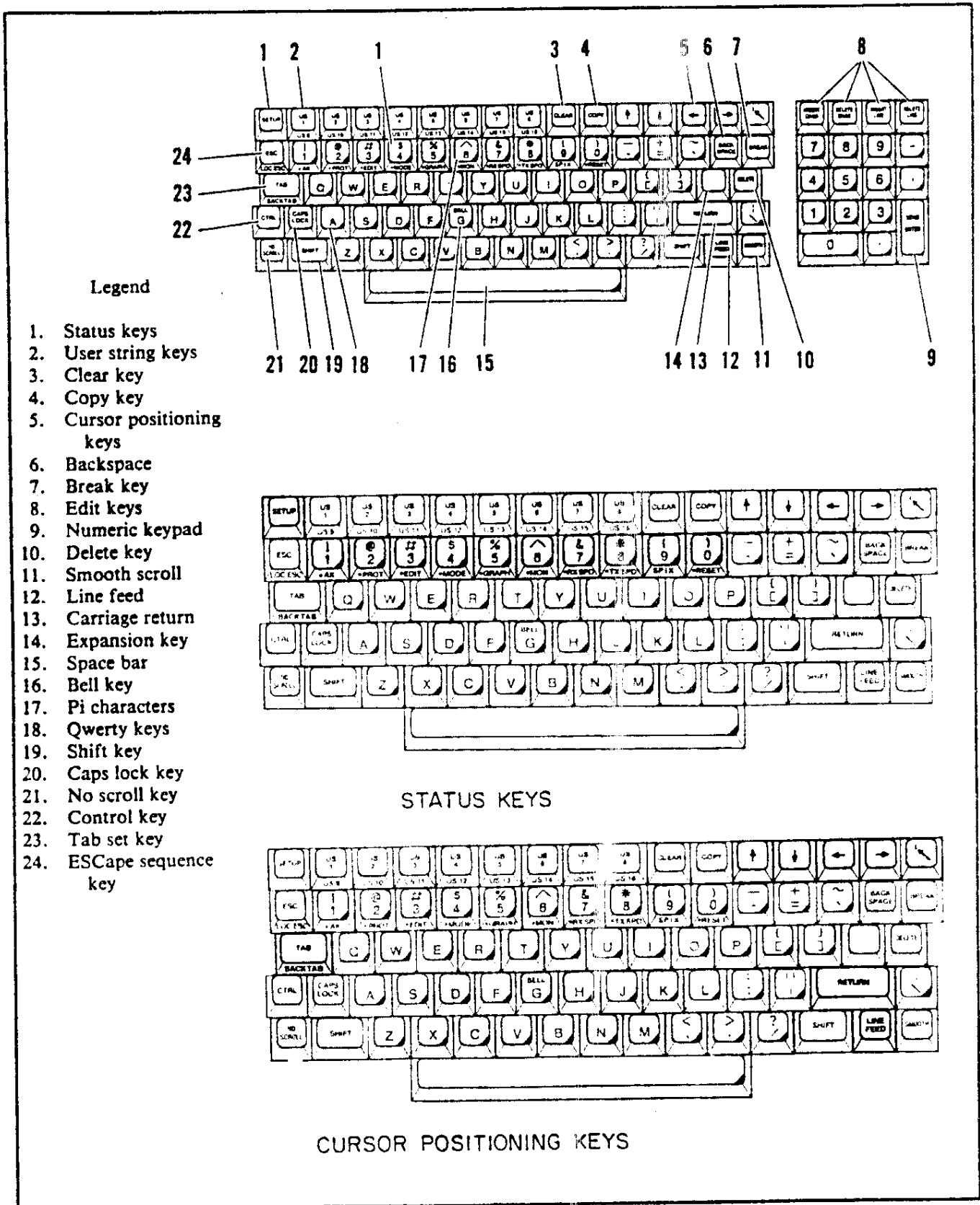
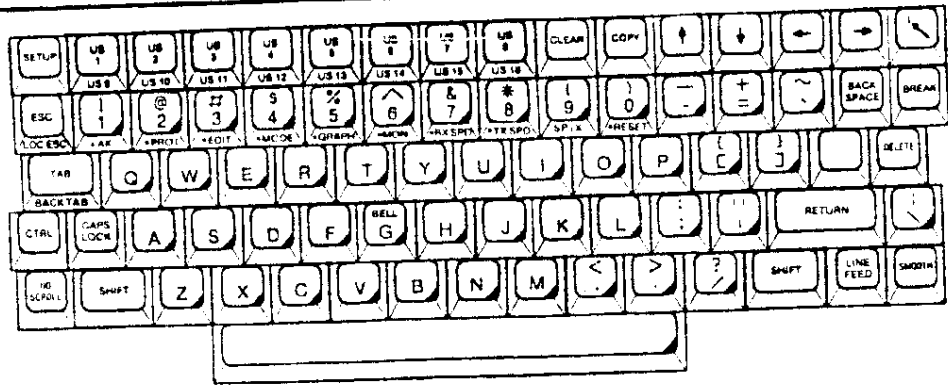

Figure 3-3 Description of Key Functions

USER STRING KEYS



GRAPHICS KEYS

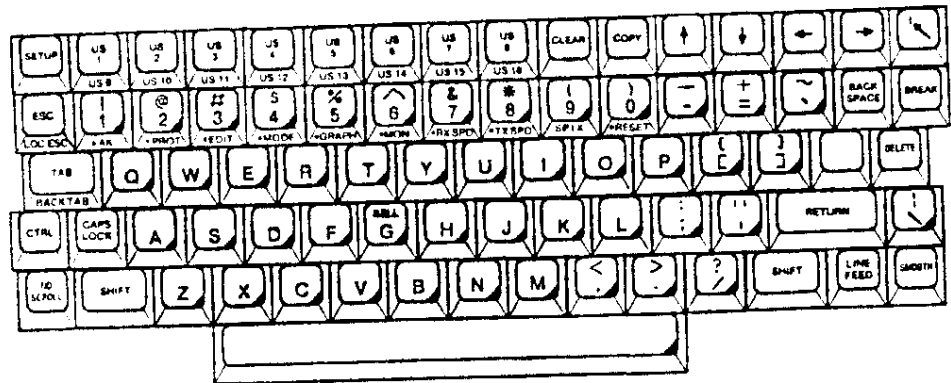

Figure 3-3 Description of Key Functions (Cont)

HDX P=0 R=01 C=01 RX=134.5 TX=134.5

(S2-2 to 4)

(S1-2 to 4)

(S1-5 to 8)

NOTE

* These fields are a function of dip-switch settings.

SET-UP PROT EDIT BLK GRPH P=0 R=01 C=01 RX=1200 TX=1200 MON AK SPI=n KBLK 00B3

(1-6)

(8-11)

(13-16)

(18-20)

(22-25)

(27-39)

(41-48)

(50-57)

(59-61)

(63-64)

(66-70)



(72-75)

(77-80)

Figure 3-4 Status Line Format

STATUS LINE SET-UP MODE

The  key, located at the top left hand corner of the keyboard, allows the operator to alter certain options set by dip-switches located on the back of the terminal, and by internal jumpering straps. To alter options proceed as follows:

- a. Press the  key to place the terminal in the set-up mode. The status line located at the bottom of the screen will display current setting of options including a blinking SET-UP designator at the far left of the status line.
- b. Press a key with yellow lettering on the lower face (ie, 1 through 8 or 0) to toggle the option to the desired state. The status line will display the new state of the option. For a list of selectable options see Table 3-1.
- c. Repeat step b. until all desired options are altered.
- d. Press the  key a second time to exit the set-up mode. The modified status line parameters are now in effect.

The options which are altered while in the set-up mode are 'volatile', that is, they will revert to the state selected by the dip-switches whenever the terminal is reset or powered-up.











KEY	FUNCTION	FIGURE REF
	Application keypad mode	3-6
	Protected fields mode	3-7
	Character insert mode	3-8
	Communication mode	3-9
	Graphics mode	3-10
	Monitor mode	3-11
	Host line receive speed	3-12
	Host line transmit speed	3-12
	Auxiliary port receive and transmit speeds (optional)	nil
	Terminal Reset	3-13

Table 3-1 Set-Up Parameters

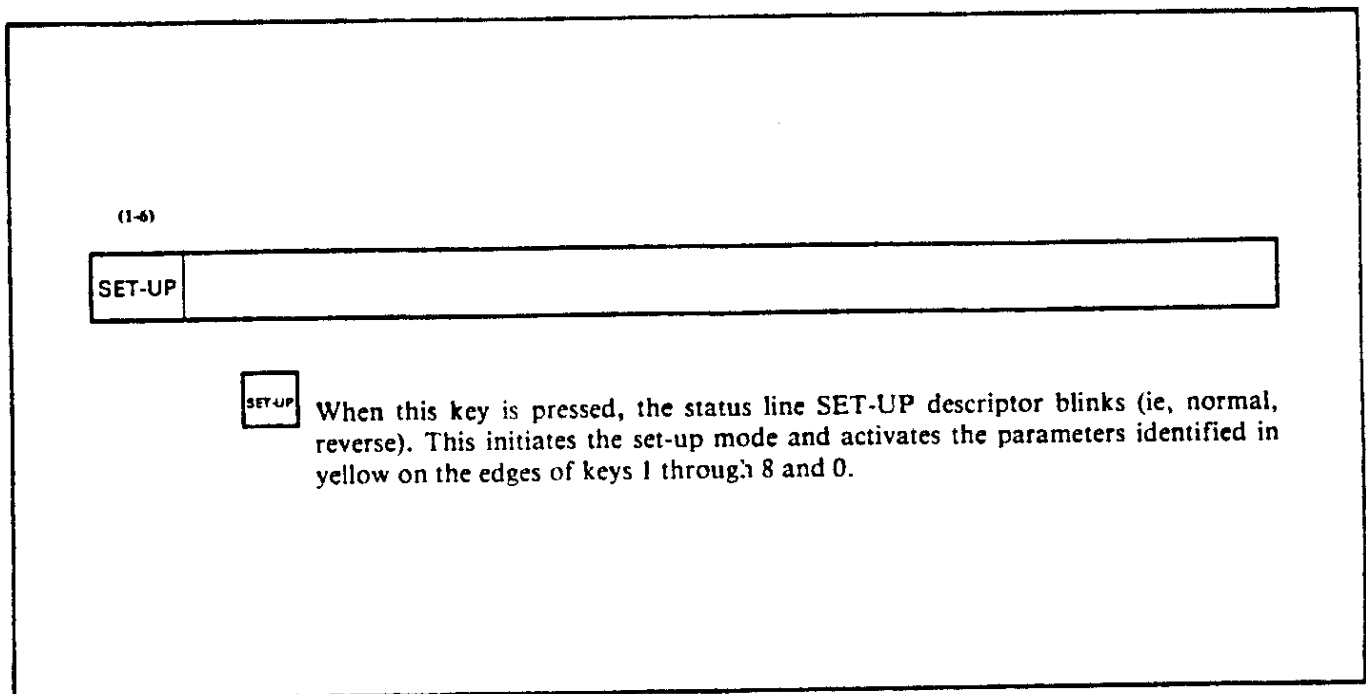
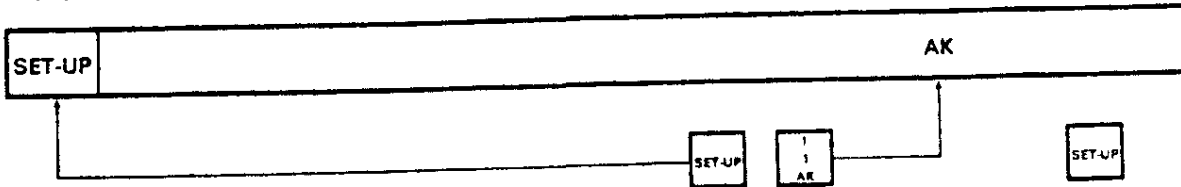



Figure 3-5 Set-Up Mode

(1-6)



(63-64)



The  key switches between the normal and applications keypad modes. (When the keypad is in the normal mode, the AK descriptor field (columns 63,64) in the status line is blank.)

The AK mode can also be entered using an ESCape sequence.

  converts the keypad to the application mode.

   reverts the keypad to the numeric mode.

































































Key	Screen Display for Normal Mode Character	Screen Display for AK Mode Character	AK Mode Function Initiated by Single Key
	0	p	   
	1	q	   
	2	r	   
	3	s	   
	4	t	   
	5	u	   
	6	v	   
	7	w	   
	8	x	   
	9	y	   
	- (minus)	m	   
	, (comma)	l	   
	. (period)	n	   

Figure 3-6 Application Keypad Mode

Key	Screen Display for Normal Mode Character	Screen Display for AK Mode Character	AK Mode Function Initiated by Single Key	*Program Function Keys
SEND ENTER	cursor moves to column 01 (same as RETURN)	M	ESC SHIFT O SHIFT M	-
INSERT CHAR	(Refer to editing modes and Figure 3-18) ESC [SHIFT @ generated	P	ESC SHIFT O SHIFT P	PF1
DELETE CHAR	(Refer to editing modes and Figure 3-18) ESC [SHIFT P generated	Q	ESC SHIFT O SHIFT Q	PF2
DELETE LINE	(Refer to editing modes and Figure 3-18) ESC [SHIFT M generated	R	ESC SHIFT O SHIFT R	PF3
INSERT LINE	(Refer to editing modes and Figure 3-18) ESC [SHIFT L generated	S	ESC SHIFT O SHIFT S	PF4

DEC VT100 Program Function (PF) Keys.* When the AK (application keypad) mode is enabled, the four edit function keys are disabled to allow for four DEC VT100-defined PF keys. The PF keys allow distinct ESCape sequences to be transmitted with a single keystroke.

When these codes are received from the host, or when the terminal is in half duplex (HDX) or local (LOC) mode, the last character will be displayed on the screen.

Figure 3-6 Application Keypad Mode (Cont)

SET-UP	PROT
--------	------

SET-UP	<table border="1" style="width: 100%; border-collapse: collapse;"> <tr> <td style="text-align: center; padding: 2px;">0 2 PROT</td> </tr> </table>	0 2 PROT	SET-UP
0 2 PROT			

The

0 2 PROT

 key switches between the protected and unprotected field modes. (In the unprotected field mode, the PROT descriptor field (columns 8-11) in the status line is blank.) A protected field is one in which the information is displayed but cannot be changed. Therefore, the information must be entered prior to creating the protected field. The protected field definition is only effective when the PROT mode is enabled and an attribute has been assigned as the protected field highlight.

The PROTected mode can also be initiated and terminated by ESCape codes. These are interchangeable with the set-up keys, therefore the most recent entry has priority and is acted upon. The ESCape codes also cause the PROT descriptor to appear in, or disappear from, the status line.

ESC	[SHIFT	?	1	9	h
-----	---	-------	---	---	---	---

 enables the PROTected mode.

ESC	[SHIFT	?	1	9	
-----	---	-------	---	---	---	--

 disables the PROTected mode.

One of the following five attributes must be assigned as the protected field highlight:

ESC	[.	;	SHIFT	}
-----	---	---	---	---	------	-------	---

when:

.

 =

0

 ...Cancels protected field definition

1

 ...Bold type implies protection

4

 ...Underlined type implies protection

5

 ...Blinking implies protection

7

 ...Reverse type implies protection

2

5

4

 ...Non-highlighted character implies protection

NOTE

If multiple attributes (separated by a semicolon) are included in the ESCape sequence erroneously, only the final one is used to select the protection attribute (ie, combinations of attributes may not be used to imply protection).

Field Definition. To create a protected field:

1. Enter the data which is to be protected and assign the required protection highlight in accordance with Figure 3-15.
2. Set up the PROT descriptor in the status line to enable this mode.
3. Define the protected field attribute in accordance with this figure.

Figure 3-7 Protected Field Mode

(1-6)

(13-16)



INS



This mode is in effect when the  key has been used to select the BLK status.

When the terminal is in the block (BLK) mode, the  key selects either the EDIT mode or the character INSert mode. Therefore, the status line reads either EDIT BLK or INS BLK. The EDIT BLK mode is the normal mode. The INS BLK provides a feature to improve efficiency. Whenever

character inserts are required, the normal procedure is to key in  prior to each character insert. In the INS BLK mode, any character or group of characters (string) which are keyed in will be inserted automatically at the cursor location without any command. Unlimited inserts can be made merely by repositioning the cursor to the point where an insertion is required. When the insertions are completed, the insert mode is terminated by changing the status to EDIT BLK.

NOTE

In any mode selection other than BLK, the  key is inhibited, therefore the EDIT field in the status line remains blank.

The INS BLOCK mode can also be entered using ESCape sequences:

       sets the INS BLK mode

       resets the mode to EDIT BLK.

Figure 3-8 Edit and Insert Mode

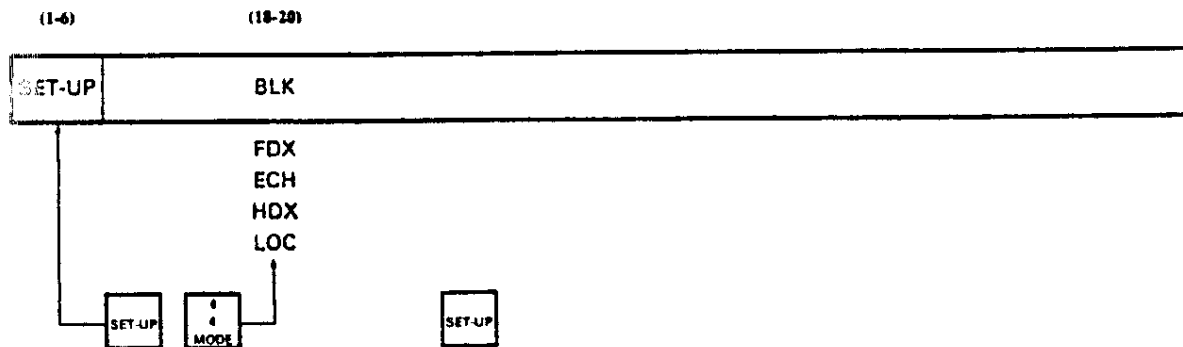

The  key provides selections of five different communications modes with the host computer as shown in field (18-20).

- BLK (Block)
- FDX (Full duplex)
- ECH (Local echo)
- HDX (Half duplex)
- LOC (Local)

The system can operate in either of two communication modes: Full duplex (FDX) or half duplex (HDX). These are described in the programmer notes, Chapter IV.

BLK (Block Mode). In this mode, the text can be modified in either the EDIT mode or INS mode.

These selections are controlled by the  key. **See Also:** Edit and Insert modes, Figure 3-8.

FDX (Full Duplex Mode). In the FDX mode, communications may take place to and from the host computer concurrently. Alternately, a higher level of control using XON/XOFF characters is supported.

NOTE

In the FDX mode, the keyboard and keypad are programmed to prevent keyboard entries directly to the screen. In a typical application, characters which are keyed in are sent directly to the host computer. The host computer then stores the data transmitted and also returns it for display on the screen.

ECH (Local Echo Mode). This is a full duplex mode variation. In the local echo (ECH) mode, every keyboard entry is transmitted to the host computer and sent directly to the screen simultaneously.

HDX (Half Duplex Mode). In the HDX mode, data can be transmitted in only one direction at a time (ie, to the terminal from the host computer; or from the terminal to the host computer).

The device which is allowed to transmit (ie, terminal or host computer) is controlled by a turn-around character (ie, CR, EOT or ETX) which is selected by dip-switch S2-2, -3, -4.

LOC (Local Mode). In this mode, keyboard entries are displayed on the screen. Communication between the terminal and host is inhibited in both directions.

Figure 3-9 Communications Mode

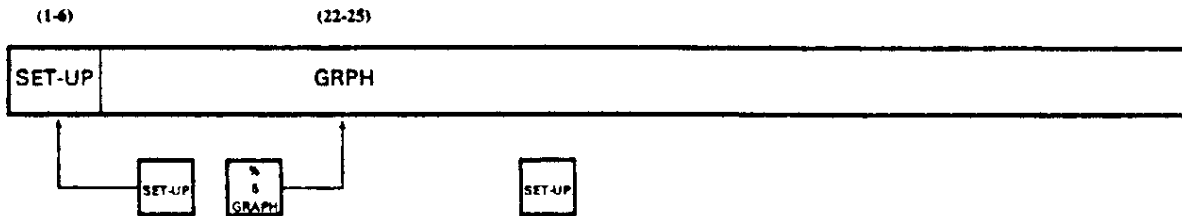

The  key enables the 32 special graphic characters which are associated with the following lower case letters and symbols:

LOWER CASE LETTER	GRAPHIC SYMBOL
-	Blank
\	◆ Diamond
a	▣ Checkerboard (Error indicator)
b	H _T Horizontal Tab
c	F _F Form Feed
d	C _R Carriage Return
e	L _F Line Feed
f	° Degree
g	± Plus/Minus
h	N _L New Line
i	V _T Vertical Tab
j	Lower Right Corner
k	Upper Right Corner
l	Upper Left Corner
m	Lower Left Corner
n	+ Crossing Line
o	- Horizontal Line - Scan 1
p	- Horizontal Line - Scan 3
q	- Horizontal Line - Scan 5
r	- Horizontal Line - Scan 7
s	- Horizontal Line - Scan 9
t	Left T
u	Right T
v	Bottom T
w	Top T
x	Vertical Bar
y	≤ Less Than or Equal To
z	≥ Greater Than or Equal To
{	π Pi
	≠ Not Equal To
}	£ UK Pound Sign
~	• Centered Dot

The special graphic characters include 15 line-graphic elements. These graphic elements are selected through the lower case alpha keys. The position in which the element will be displayed on the screen is established by the current location of the cursor. By this method, pictorials can be generated similar to the one illustrated. The illustration identifies each of the 15 line elements according to the key. It also shows the checkerboard symbol. For example, entering a sequence of q's generates an unbroken horizontal line; a sequence of x's down a column (ie, x, line feed, back-space, x, etc) generates an unbroken vertical line. Keys l, k, j and m produce corners in the appropriate orientation.













NOTE

In the illustration, the lines are shown broken for clarity so that the line elements are visible. On the display, the elements intersect so that a line becomes continuous.

Graphic symbols also include superscript characters (eg, H_T for flagging a horizontal tab); math symbols (eg, ≤ less than or equal to), and the checkerboard character ▣.

Figure 3-10 Graphics Mode

To exit graphics mode:

1. Operate the    keys to remove GRPH from the status line.
2. Key in      (for ASCII character set G0).
3. Key in      (for ASCII character set G1).

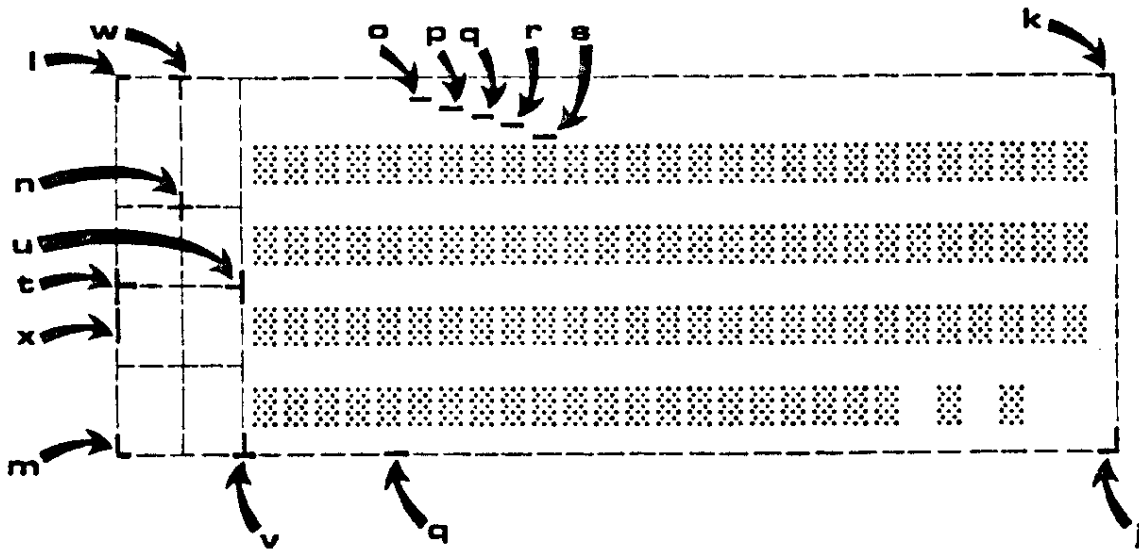
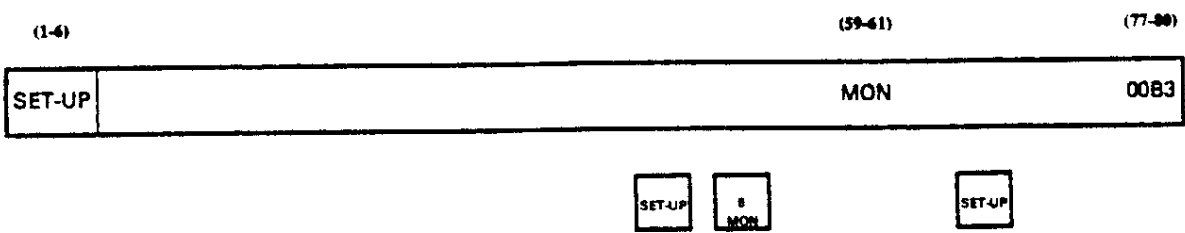

Figure 3-10 Graphics Mode (Cont)



In the monitor mode, all characters received from the host computer are displayed on the screen. Control characters are displayed with a superscript (eg; CTRL A displays ^{CTRL}A). As each character enters, the cursor advances one column. After the end of row is reached the cursor advances to column 01 in the next row.

Firmware Identification Code: In the monitor mode, an identification code is displayed at the end of the status line. The format is as follows:

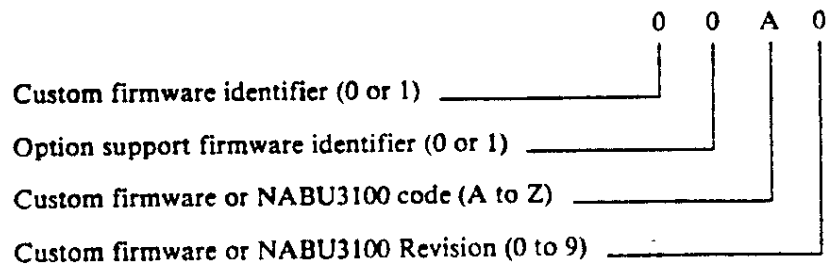
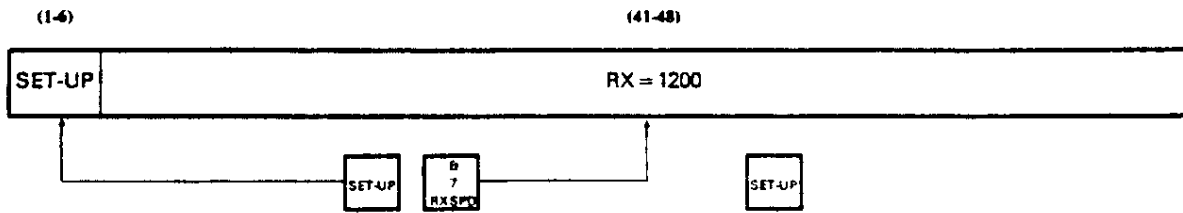

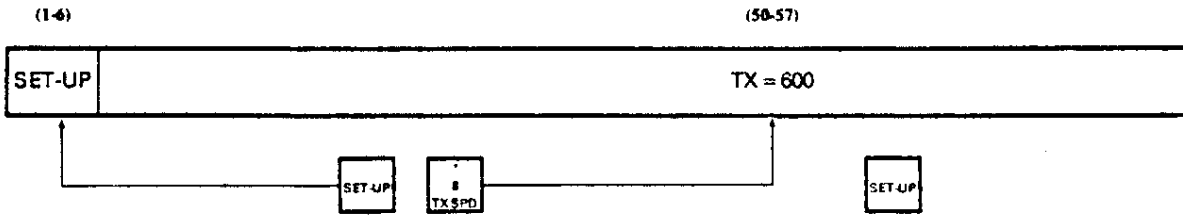

Figure 3-11 Monitor Mode



Receive Speed (Baud Rate)

The  key changes the baud rate of transmissions from the host computer. The initial baud rate is set in by dip-switch S1-1, -2, -3, -4. See Figure 3-2. Fifteen different rates are available. Repetitive pressing of the key, steps through the sequence of rates offered.



Transmit Speed (Baud Rate)

The  key changes the baud rate of transmissions to the host computer. The initial baud rate is set in by dip-switch S1-5, -6, -7, -8). See Figure 3-2. Fifteen different rates are available. Repetitive pressing of the key, steps through the sequence of rates offered.

NOTE

The receive and transmit baud rates are set independently therefore they can have different values.

Figure 3-12 Receive (RX) and Transmit (TX) Speeds

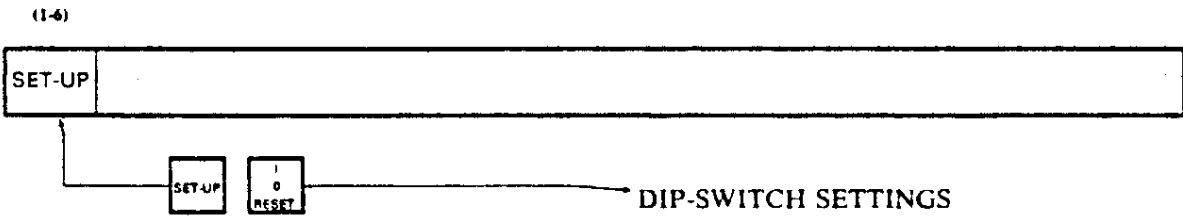

When  is keyed in, the terminal reverts to the settings of the dip-switches, the screen is cleared and the status line displays the dip-switch and jumpering selections.

NOTE



Reset can also be executed by the command;  

Figure 3-13 Status Reset

CHARACTER PRESENTATION ON SCREEN



The characters are generated by ROM/PROM chips. Each character is formed in a 7 × 9 dot matrix within a 9 × 10 dot field. This gives a character size of approximately 14 point. The rows are separated by a 2 dot descender line space. The refresh memory is static RAM. (Refer also to character width functions.)

The character set comprises 128 ASCII characters. These include upper and lower case letters, and 32 line graphics characters.

A character is generated when the requisite key is pressed. The character appears on the screen in the position of the cursor. The cursor then advances one column to the right.

Audible Feedback

Short Tone. If this feature is selected by dip-switch S3-6, a click sound will be heard every time that a key is

pressed except for the  and . This simulates the sound of a conventional typewriter.

Long Tone. A long tone or beep occurs whenever:

1. a BELL code is received from either the host computer or from the keyboard when operating in the half duplex (HDX) or local echo (ECH) modes;
2. an error is made while entering data in the EDIT mode;
3. the terminal input buffers have overflowed.

Character Set Selection

The terminal has three character sets: US ASCII, UK ASCII and line graphics characters. See Figure 3-14.

Any two character sets may be available at any one time. The terminal selects between them by designating one as group 0 (G0) and one as group 1 (G1).

The user can select between the two designated sets in the following way:

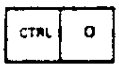
 (shift in) causes all characters which follow the command to be displayed from G0.

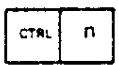
 (shift out) causes all characters which follow the command to be displayed from G1.

NOTE

The terminal powers up with G0 selected.

Character Attributes



The following attributes may be set for any screen character: blink, reverse, underscore, bold.

Each character or field may have any combination of up to three of the following attributes: blink, reverse, underscore and bold. All four attributes may **not** be set at the same time for any single character. If an ESCape sequence attempts to implement four highlights, the final attribute that was programmed, will be ignored.



These attributes do **not** use any displayable screen memory. They are implemented as additional bits for each character. The ESCape sequence is inserted immediately prior to the character(s) to be highlighted. All characters which follow this ESCape sequence will be highlighted with the attributes until the ESCape sequence is changed or cancelled.

Character Width Functions

The size of each character is normally contained in a 7 × 9 dot matrix. The line width function can be changed by the ESCape sequence:





  # 

to give extended (double width) characters along the line following the ESCape entry. The feature can be terminated by a delimiter ESCape sequence:





  # 

Screen Background

There are two ESCape sequences which modify the display background.

   ?  

This causes the characters to be displayed in reverse video (ie, white, or coloured background, black characters).

   ?  

This causes the characters to be displayed in normal video (ie, black background, white or coloured characters.)

CURSOR CONTROL

At power up or following reset, the cursor is located at the home position (ie, row 01, column 01). As data is entered, the cursor travels across the screen in the space following the most recent keystroke character or entry. When the cursor reaches column 80 it remains stationary and additional keyboard entries will occur in column 80, each character entry superseding the previous one. Cursor positioning keys are explained in Figure 3-16.

The set associated with G0 is specified as follows:

ESC SHIFT (SHIFT B

is the US ASCII character set.

ESC SHIFT (0

is the graphics character set.

ESC SHIFT (SHIFT A

is the UK ASCII character set.

ESC SHIFT (1

is the alternate character set (optional).

Similarly the set associated with G1 is specified as follows:

ESC SHIFT) SHIFT B

is the US ASCII character set.

ESC SHIFT) 0

is the graphics character set.

ESC SHIFT) SHIFT A

is the UK ASCII character set.

ESC SHIFT) 1

is the alternate character set (optional).

NOTES

1. It is legal to have G0 and G1 specify the same character set.
2. At power up, G0 and G1 both specify the US ASCII character set.

Figure 3-14 ESCape Codes which Define G0 and G1

The escape sequence for a single character attribute is:

ESC [* m

and for multiple attributes:

ESC [* ; * ; * m

The * keys are selected numerics, as follows:

ESC [1 m Bold on

ESC [4 m Underscore

ESC [5 m Blink on

ESC [7 m Reverse video on

The ESCape sequence:

ESC [m or ESC [0 m

turns off all attributes. It is inserted following the last character which is to be highlighted. All characters which follow, will appear in the normal colour on black background.

Figure 3-15 Character Attributes

The directional (arrow) keys shown in Figure 3-16, move the cursor in the N, S, W or E direction shown towards the edge of the screen. When a key is pressed, movement occurs whether the display adjacent to the cursor is blank or contains characters. The arrow keys

are repetitive so that if a key is held pressed, the cursor travels across the screen. It becomes stationary at the edge of the display area. The diagonal (NW) arrow moves the cursor directly to the home position (R = 01, C = 01) without appearing in the intermediate positions.















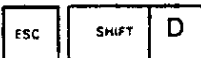

Cursor Positioning Keys	Function	Special Escape Sequence
	Moves cursor towards row 01 (See Note 1)	 (* = number of rows that cursor will move)
	Moves cursor one line towards row 01. If cursor is in row 01, screen text will scroll down one row.	
 OR 	Moves cursor towards row 24 (See Note 1)	
	Moves cursor one line towards row 24. If cursor is in row 24, screen text will scroll up one row.	
 OR 	Moves cursor towards column 01 (See Note 1)	
	Moves cursor towards column 80 (See Notes 1 and 2)	
	Moves cursor directly to home (ie, row 01, column 01) (See Note 3)	 
	Moves cursor to a specific co-ordinate (ie, row *, col **)	 

Figure 3-16 Cursor Control

Cursor Positioning Keys	Function	Special Escape Sequences
<div style="border: 1px solid black; padding: 2px; display: inline-block; margin-bottom: 5px;">RETURN</div> <div style="border: 1px solid black; padding: 2px; display: inline-block;">LINE FEED</div>	performs carriage return and line feed	<div style="border: 1px solid black; padding: 2px; display: inline-block; margin-right: 5px;">ESC</div> <div style="border: 1px solid black; padding: 2px; display: inline-block; margin-right: 5px;">SHIFT</div> <div style="border: 1px solid black; padding: 2px; display: inline-block;">E</div>
	Saves in memory the cursor co-ordinates and the condition of the attributes assigned to that location	<div style="border: 1px solid black; padding: 2px; display: inline-block; margin-right: 5px;">ESC</div> <div style="border: 1px solid black; padding: 2px; display: inline-block;">7</div>
	Restores (positions) the cursor at the co-ordinates which were saved. If the ESCape code occurs prior to a save code, the reset default settings are used.	<div style="border: 1px solid black; padding: 2px; display: inline-block; margin-right: 5px;">ESC</div> <div style="border: 1px solid black; padding: 2px; display: inline-block;">8</div>
	Initiates keyboard auto repeat	<div style="border: 1px solid black; padding: 2px; display: inline-block; margin-right: 5px;">ESC</div> <div style="border: 1px solid black; padding: 2px; display: inline-block; margin-right: 5px;">[</div> <div style="border: 1px solid black; padding: 2px; display: inline-block; margin-right: 5px;">SHIFT</div> <div style="border: 1px solid black; padding: 2px; display: inline-block; margin-right: 5px;">?</div> <div style="border: 1px solid black; padding: 2px; display: inline-block; margin-right: 5px;">8</div> <div style="border: 1px solid black; padding: 2px; display: inline-block;">h</div>
	Discontinues keyboard auto repeat	<div style="border: 1px solid black; padding: 2px; display: inline-block; margin-right: 5px;">ESC</div> <div style="border: 1px solid black; padding: 2px; display: inline-block; margin-right: 5px;">[</div> <div style="border: 1px solid black; padding: 2px; display: inline-block; margin-right: 5px;">SHIFT</div> <div style="border: 1px solid black; padding: 2px; display: inline-block; margin-right: 5px;">?</div> <div style="border: 1px solid black; padding: 2px; display: inline-block; margin-right: 5px;">8</div> <div style="border: 1px solid black; padding: 2px; display: inline-block;">I</div>
	Initiates autowrap	<div style="border: 1px solid black; padding: 2px; display: inline-block; margin-right: 5px;">ESC</div> <div style="border: 1px solid black; padding: 2px; display: inline-block; margin-right: 5px;">[</div> <div style="border: 1px solid black; padding: 2px; display: inline-block; margin-right: 5px;">SHIFT</div> <div style="border: 1px solid black; padding: 2px; display: inline-block; margin-right: 5px;">?</div> <div style="border: 1px solid black; padding: 2px; display: inline-block; margin-right: 5px;">7</div> <div style="border: 1px solid black; padding: 2px; display: inline-block;">h</div>
	Discontinues autowrap	<div style="border: 1px solid black; padding: 2px; display: inline-block; margin-right: 5px;">ESC</div> <div style="border: 1px solid black; padding: 2px; display: inline-block; margin-right: 5px;">[</div> <div style="border: 1px solid black; padding: 2px; display: inline-block; margin-right: 5px;">SHIFT</div> <div style="border: 1px solid black; padding: 2px; display: inline-block; margin-right: 5px;">?</div> <div style="border: 1px solid black; padding: 2px; display: inline-block; margin-right: 5px;">7</div> <div style="border: 1px solid black; padding: 2px; display: inline-block;">I</div>

NOTES

1. The cursor stops at the end of a physical screen boundary if the boundary is encountered prior to completion of the cursor move; (eg, if

ESC

[

9

SHIFT

A

 is entered when the cursor is less than 9 rows from the top of the screen, the cursor moves to the top line and stops).
2. Even if the autowrap SET-UP feature is enabled, the cursor will not move past the right edge of the screen (column 80) when this ESCape sequence is used.
3. Permutations of 1:0, blank for line and 1:0, blank for column will also cause the cursor to move to the home position.

ESC

[

SHIFT

H

 is generated by the

'R

 key.

Figure 3-16 Cursor Control (Cont)





Page Records

When there is no expanded memory option, the display reads P=0. See Figure 3-17. This is not relevant in the standard terminal.

Cursor Position Indicator

The co-ordinates of the cursor are displayed in fields 31-34 and 36-39 for the row and column respectively. Refer to Figure 3-17.

Cursor Position Reporting

    is a host invocation. When the host sends this sequence to the terminal it is a request for the cursor position (co-ordinates).

The terminal response is:

Where  = the row number in which the cursor is located.

 = the column number in which the cursor is located.

(27-39)

P=0 R=01 C=01

P=0

The P value indicates the page. A page is defined as a complete screen block. In the standard version, the buffer memory can only accommodate one page, therefore, the status line indication remains at P=0. Using an optional expanded memory, the P value will be changed accordingly up to a limit of 8 pages.

Cursor Position Indicator

R=01 and C=01 are co-ordinate indicators for the location of the cursor:

- The Y axis co-ordinate is defined in terms of row number R and can vary from 01 (top row) to 24 (bottom row) (or to row 25 if the status line is deleted).
- The X axis co-ordinate is defined in terms of column number C and can vary from 01 (LH column) to 80 (RH column).

The home position is R=01, C=01. The indicators are counting types, therefore when the cursor moves to the right or moves downwards, the counters increment, and vice versa.

NOTE



There is no key access to these fields.

Figure 3-17 Page and Cursor Position Indicator

EDITING MODES

The terminal provides various functions associated with text and data editing. Functions include: basic editing, such as adding and deleting characters displayed on the screen; display and protection from overwriting of entry formats which assist the user in entering the required data.

Block Editing Modes

There are two modes: editing (EDIT BLK) and inserting (INS BLK). These modes are initiated by the  key and keys  and .

EDIT BLK Mode. In this mode, the entries to the screen are not transmitted directly to the host. Therefore text editing can be carried out using the editing keys so that validated text is sent to the host when commanded. Editing is accomplished using the keys or sequences shown in Figure 3-18.

INS BLK Mode. This mode is identical to the EDIT BLK mode except that character insertion occurs automatically wherever the cursor might be positioned. Any character inserts at the location of the cursor will cause the characters to the right of the cursor including the character at the cursor location to shift to the right. Simultaneously the character in column 80 will disappear with each character insert.

Editing Keys. There are four editing keys located in the top row of the key pad. The editing keys control the insertion or deletion of a character or line within the display. The screen co-ordinates at which the editing action occurs is established by the position of the cursor. See Figure 3-18.

Clear Key. The  key in the primary keyboard provides several deletion functions as defined in Figure 3-19. The equivalent ESCape codes are also shown.











Key	Escape Code	Function
	   	<p>This function causes the character under the cursor and all the following characters on that line to the right of the cursor to move one column to the right. The character to be inserted is placed at the cursor position. Any characters which become shifted past column 80 or a field boundary are lost. They do not wrap around and shift to the next line.</p> <p style="text-align: center;">NOTE</p> <p>When the terminal is in the PROTECT mode, the EDIT BLK mode is overridden. The  key will permit the insert of characters from the cursor position to the end of the line or to the first protected field.</p> <p>where * represents the number of column spaces to be inserted in a line.</p>
	or	
	    	

Figure 3-18 Editing Keys

Key	Escape Code	Function
DELETE CHAR	ESC [SHIFT P	<p>This function causes the character at the cursor position to be deleted and moves all the following characters on that line one column to the left. Column 80 remains blank. At the conclusion of a delete function, insert characters can be written into the last position on the line (ie, normally column 80).</p> <p style="text-align: center;">NOTE</p> <p>When the terminal is in the PROTECT mode, character deletion operates in the line from the cursor position to the end of the unprotected field or line.</p>
	OR	
INSERT LINE	ESC [* SHIFT P	<p>where * represents the number of characters to be deleted from the cursor position to the right.</p> <p>This function causes the line in which the cursor is located and lines below it within the scrolling region to move down one line and a blank line is inserted. The bottom line in the scrolling region is lost. The cursor then takes up a position in column 01 of the line which was inserted.</p> <p style="text-align: center;">NOTE</p> <p>This function has no effect if the terminal is in the PROTECT mode.</p>
	OR	
INSERT LINE	ESC [* SHIFT L	<p>where * represents the number of row spaces to be inserted ahead of the cursor row.</p> <p style="text-align: center;">NOTE</p> <p>This escape sequence will treat protected fields as if they are unprotected. Therefore, it may only be invoked if the terminal is not in the PROTECT mode.</p>
	OR	
INSERT LINE	ESC [SHIFT M	<p>This function causes the line which contains the cursor to be deleted. All lines below it within the scrolling region move up one line to replace the deleted line. A blank line is entered at the bottom of the scrolling region. The cursor then takes up a position in column 01 of the line which followed the deleted line.</p> <p style="text-align: center;">NOTE</p> <p>This function has no effect if the terminal is in the PROTECT mode.</p>
	OR	
INSERT LINE	ESC [* SHIFT M	<p>where * represents the number of rows to be deleted commencing at the row which contains the cursor.</p> <p style="text-align: center;">NOTE</p> <p>This escape sequence will treat protected fields as if they are unprotected. The command will only work within a scrolling region. It may only be invoked if the terminal is not in the PROTECT mode.</p>
	OR	

Figure 3-18 Editing Keys (Cont)

Key	Escape Code	Function
CLEAR	ESC [SHIFT K OR ESC [0 SHIFT K	Deletes characters from the cursor to the end of the line including the cursor position
SHIFT CLEAR	ESC [1 SHIFT K	Deletes characters from the beginning of the line up to and including the cursor position
SHIFT CLEAR	ESC [2 SHIFT K	Deletes entire line in which the cursor is positioned
CTRL CLEAR	ESC [0 SHIFT J OR ESC [SHIFT J	Deletes characters from the cursor to the end of the screen including the cursor position
CTRL CLEAR	ESC [1 SHIFT J	Deletes characters from the beginning of the screen up to and including the cursor position
CTRL SHIFT CLEAR	ESC [2 SHIFT J	Clears entire screen
NOTE		
When a deletion is initiated, the cursor does not move. If a line which contains double width characters is deleted, any characters which are subsequently inserted will be single width.		
Erasing Modes	ESC [6	This sequence causes a CLEAR command to erase all data including protected fields
	ESC [6 h	This sequence causes a CLEAR command to erase data in unprotected fields only

Figure 3-19 Deletion Keys and Sequences

TAB FUNCTIONS



Default Tabs. At power up, tabs are set automatically at column 9, and at increments of eight columns (ie, 9, 17, 25 73).

Setting Tabs. Tabs may be set in each and every column. When setting tabs, the row in which the cursor is located is irrelevant because a set tab is effective in all rows. A tab is set by placing the cursor in the desired



column then entering:   .





Tab Key. When tabs have been set up and the  key is pressed, the cursor will move to the right and stop at the next tab. If no tabs are set, the cursor moves to column 80.

Back Tab. When tabs have been set up and the





  keys are pressed, the cursor will move to the left and stop at the previous tab. If no tabs are set, the cursor moves to column 01.





Tab Function Escape Codes.

   Sets a horizontal stop (tab) in the column at the cursor location.

    clears the horizontal tab from the column at the cursor location.

    clears all horizontal tabs.

    advances the cursor a specific number of tabs determined by the numeric *.

    moves the cursor to the left a specific number of tabs determined by the numeric *.

NOTE

Tabs are not active in the PROTECT mode. If the

 key is pressed in this mode, the cursor moves to the left hand column of the first unprotected field to the right of the cursor.

USER STRING (US) KEYS









There are eight user string keys in the main keyboard. See Figure 3-3. Each key has two levels: In the unshift position, the keys are US1 through US8; in the shift position, the same keys become US9 through US16 respectively.







The US keys may have a string (sequence) of information associated with them. This saves keying in redundant or repetitive data.

The memory assigned to the 16 US keys can hold up to a total of 240 character bytes. For each message associated with a US key, an extra character byte is required by the processor for control purposes. Therefore the total number of bytes is 256.

When the terminal is first powered on, the US key memory is cleared therefore the keys do not yield any messages.

Each US key is programmed via an ANSI escape sequence as follows:

     
 character string 

 represents a numerical value between 1 and 16. The  assigns the  character string  to the corresponding user key (ie,  through .

 may be any delimiter which is not found in the character string. The delimiter is not embedded in the character string when it is recalled.

NOTE

Any character string can be replaced by programming another string in the same location.

SCROLLING REGION (SPLIT SCREEN)

The system allows a single scrolling region to be placed anywhere on the display screen. Scrolling can then take place within the window.

This split screen region must be a minimum of two consecutive rows. It can also occupy the entire screen.

NOTE

The split screen is only available vertically.

The ESCape code which defines the scrolling region is:

where:  = the row number between 1 and 24 which defines the upper limit of the scrolling area.

 = the row number between 1 and 24 which defines the lower limit of the scrolling area.

The area outside the scrolling region is fixed; (ie, it cannot be scrolled) but data may be written into this area.

Cursor addressing may be selected to affect the entire screen (absolute addressing) or it may be limited to the scrolling region (relative addressing).

When the cursor is in the scrolling region, the cursor may only be moved outside the region by absolute cursor addressing or by resetting the terminal.



ESC [SHIFT ? 6 |

This sequence allows the cursor to enter data into the total display (ie, absolute addressing), from the home position (R=01, C=01).

ESC [SHIFT ? 6 h

This sequence allows the cursor to enter data into the scrolling window (ie, relative addressing).

Scrolling within the window area occurs in either direction. To scroll upwards, place the cursor on the bottom line of the window then use the  key to scroll the text.

To scroll downwards, place the cursor on the top line of the window, then use the    sequence to scroll the text.

NOTE

The  key is related to transmission modes, not scrolling.

The  key changes the scrolling motion alternately from a jump scroll to a visually smooth scrolling action. No code is sent to the host computer.

ESC [SHIFT ? 4 h

This sequence enters the smooth scrolling mode.

ESC [SHIFT ? 4 |

This sequence enters the jump scrolling mode.

Upon power up or reset, the terminal uses the entire screen as the scrolling region.

SCREEN ALIGNMENT DISPLAY

The following command fills the entire display area with 'E's. This is used by Nabu manufacturing and field personnel.

ESC . SHIFT # 8

This chapter provides information and programming instructions. Therefore, it is important that Chapter III be studied first in order to gain a total knowledge of the system and its facilities.

COMMUNICATION MODES

The system can communicate in either the full duplex (FDX) or the half duplex (HDX) mode. Furthermore, the terminal provides five transmission modes.

1. In the local mode (LOC), characters entered on the keyboard are sent directly to the display for presentation or control. Characters sent by the host are ignored.
2. In the block mode (BLK), keyboard entries are sent to the display. Then, under keyboard command, entries are sent as a block of text to the host computer. Characters sent by the host are processed.
3. In the full duplex (FDX) mode, keyboard entries are sent directly to the host. If the host chooses to echo the received data, it is displayed on the terminal.
4. In the local echo (ECH) mode, keyboard entries are sent to the host and to the display, simultaneously. This provides a visual record of transmitted characters.
5. In the half duplex (HDX) mode, data can only be transmitted in one direction at a time. Turn-around codes are used to establish which device can transmit. When the terminal is in control, keyboard entries are sent to the host and to the display simultaneously.

Operation Modes

The type of transmission is established initially by dip-switch selections (S2-2, -3, -4). See Figure 3-2. These can be changed by volatile settings within the status line,

using the  key. See Figure 3-5. Some of these may also be modified with ESCape sequences.

NOTE

The desired duplex mode is selected by the terminal and cannot be changed by the host computer.

RS-232C Handshaking. In the description of the communication modes, references are made to the condition of RS-232C pins (ie, asserted or de-asserted). Typically, these include: TX Data (Pin 2); RX Data (Pin 3); RTS (Pin 4); CTS (Pin 5); DSR (Pin 6); SUP TX (Pin 11) and DTR (Pin 20). See Table 2-1.

RS232C PARAMETERS

The input-output parameters are established by dip-switch selections. They include baud rate; word length; parity and stop bits.

Baud Rates. Baud rates between the host and terminal are set up separately for the transmit and receive channels. Therefore, they can be set at different values. The receive speed is set by S1 (-1 to -4) and the transmit speed by S1 (-5 to -8). See Figure 3-2. These can be changed by keyboard selections into the status line. See Figure 3-12.

Word Length. Dip-switch S2-6 sets the terminal to transmit and receive either 7 or 8 bit characters. When set for 8 bit operation, bit 8 is set to a space (or 0) for characters transmitted and is ignored from all characters received.

Parity. There are three parity selections: none, even or odd. Dip-switch S2-17 is the parity switch which selects either parity on, (1), or none, (0). If parity on is selected, the S2-18 selects even (1) or odd (0) parity. The parity selected applies to all data communication including data transmitted to the host; data received from the host; data transmitted to the serial peripheral interface (SPI) and data received from the SPI.

For received data, if even or odd parity is selected, and a parity error is detected; a  is displayed on the screen and the cursor advances one position.

For transmitted data, if no parity is selected, 8 data bits are transmitted with the most significant data bit in a marked condition.

Stop Bits. Dip-switch S2-5 sets the terminal to transmit and receive either 1 or 2 stop bits. One stop bit is all that is normally required except at baud rates 50, 75 and 110.

CONVERSATIONAL CONTROL FUNCTIONS

Control functions sent between the terminal and host computer can be initiated automatically and by the user.

Transmission Control Codes

Break Key. When this key is pressed, it causes the terminal to lower the data transmit line to a space condition during the period that the key is held pressed.

Escape Sequences. Escape codes are generated by a string of keyed entries which have been created in accordance with the following rules: For example,

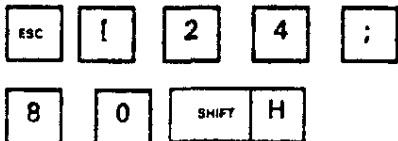

1. An ANSI (American National Standards Institute) ESCape sequence is initiated by the ASCII ESC character, (1B Hex). This is produced by the single

keystroke .

2. An ANSI ESCape sequence is terminated by a terminating ASCII character in the range (30 Hex) to

(7E Hex). In the example, .

3. An ASCII lead-in character may be present

following . These characters are:



The symbol [is the single ASCII character (5B Hex) and is called an 'open square bracket'.

4. All ASCII characters in the range (00 Hex) to (1F Hex) are control codes when embedded in an ESCape sequence and are executed as such without disturbing the ESCape sequence transmission.

5. If an ESC character is inserted in the middle of an ESCape sequence, it causes the current ESCape sequence transmission to be aborted and a new sequence to be initiated.

6. The ASCII CAN, (18 Hex), and SUB, (1A Hex), characters cause the ESCape sequence under transmission to be aborted.

Interrogation Codes

What are you. A request for 'what are you?' might be sent to the terminal by the host. The invocation will be:



The immediate response from the terminal shall be:



Status Report. A status request might be sent to the terminal by the host. The sequence will be:



The immediate reply from the terminal shall be one of the following:

indicating OK (ready to communicate).

indicating not OK.

FULL DUPLEX (FDX) MODE

This mode is established when dip-switches S2-2, -3, -4 are set to 0,0,1 respectively. It can also be set up by the MODE key through the status line. In this mode, keyboard entries are sent only to the host and stored. The host must echo the codes if they are to appear on the terminal display. This permits instantaneous visual validation of the data to confirm that it was transmitted accurately. Communication between the terminal and host may occur concurrently. Optionally, a higher level of control, using XON/XOFF signals is provided.

RS-232C Handshaking. In this mode, the data terminal ready (DTR) signal is normally asserted. The request to send (RTS) is always asserted. Data transmission can only occur, if the data set ready (DSR) and clear to send (CTS) are asserted by the host computer.

Local Echo. This function applies to the full duplex mode. If dip-switches S2-2, -3, -4 are set to 0,1,1 respectively, or if ECH is set up by the MODE key through the status line, every character transmitted to the host is also transmitted to the terminal display. The terminal acts upon those characters as if they had been echoed from the host.

NOTE

Any characters received from the host will intermix with local echo characters. Therefore, normally, it is desirable to inhibit host echoes.

Data Flow Control in FDX. The terminal operates at speeds up to 9,600 baud. However, at the higher speeds the terminal may not be able to accommodate the incoming data.

The terminal stores the incoming data in an 80-character buffer and then processes it sequentially on a first-in, first-out basis.



When the buffer contents reach 64 characters, the terminal transmits an XOFF (DC3) and /or de-asserts the DTR (data terminal ready). The precise terminal action depends upon the settings of dip-switches S3-18 and -17 respectively. When the host computer receives this command, it must interrupt its transmission to the terminal.



If the host suspends transmission, the terminal processes the data and empties the buffer. When the buffer content is reduced to 16 characters, the terminal transmits an XON (DC1) and/or re-asserts the DTR to command the host to resume data transmission. This again depends upon the settings of the dip-switches.

NOTE

If the host fails to respond to the protocol used by the terminal (ie, XOFF and/or DTR) or if no protocol has been selected by the dip-switches, the buffer continues to fill to the 80-character capacity. When the buffer overflows, the terminal discards the incoming characters and may also display an error character  (a checkerboard) on the screen.

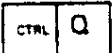
In addition to the buffer-filling condition, there are two

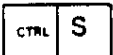
other means of transmitting XON/XOFF: the  key; and the  and . The terminal co-ordinates these three sources so that the desired effect occurs. If the XON/XOFF feature is disabled, the buffer filling does not send XOFF.

 and  are transmitted as typed and the  key does not use XON/XOFF.

DTR handshaking can also be controlled by the  key. The terminal co-ordinates the two sources of DTR,

(ie, the buffer filling condition and  key), handshaking in the same manner as it does for XON/XOFF. If the DTR feature is disabled, the buffer filling

condition does not de-assert DTR and the  key does not affect DTR handshaking.

If the XON/XOFF and DTR features are both disabled, the  key is also disabled.

Computer systems which do not respond to XON/XOFF or DTR signals from the terminal may still be used with the terminal provided that:

1. The host never sends the ESC code.
2. The baud rate is limited to less than 4800.
3. The host does not use smooth scrolling.

HALF DUPLEX (HDX) MODE

This mode is established when dip-switches S2-2, -3, -4 are set to one of the three HDX turn-around codes. It can also be set up by the MODE key through the status line. In this mode, information can only be transmitted *in one direction at a time*. Therefore the master-slave relationship is established by turn-around codes. When the terminal is in control, keyboard entries are sent to the host and the display simultaneously.

RS232C Handshaking. In this mode, the data terminal ready (DTR) signal is normally asserted. The request to send (RTS) is de-asserted at power up or following terminal reset. The RTS is asserted whenever a transmission from the terminal to the host is initiated. The RTS is de-asserted whenever a turn-around character is sent by the terminal. Data transmission can only occur, if the data set ready (DSR) and clear to send (CTS) are asserted by the host computer.

Turn-Around Codes. Dip-switches S2-2, -3, -4 select the operation mode. See Figure 3-2. Three of the selections are turn-around codes for the HDX mode:

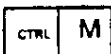
CR (1,0,0) is the carriage return 

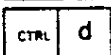
EOT (1,1,0) is the end of tape 

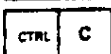
ETX (1,1,1) is the end of text 

(ETX is also the default code, when HDX is set up through the status line.)

LOCAL (LOC) MODE

This mode is established when dip-switches S2-2, -3, -4 are set to 0,0,0. It can also be set up by the MODE key through the status line. In this mode, characters which are entered on the keyboard are sent directly to the screen for display or control.

RS-232C Handshaking. In this mode, the data terminal ready (DTR) signal is normally de-asserted. The request to send (RTS) is de-asserted. Data received from the host is discarded.

Data Flow in Local. Characters entered through the keyboard are sent to the display. Terminal control codes and ESCape sequences are acted upon as if they were received from the host (DCE). After the data has been entered, it can be transmitted to the host by setting the terminal to the EDIT BLK mode (Figure 3-8) and then initiating a SEND.

BLOCK (BLK) MODE

This mode is established when dip-switches S2-2, -3, -4 are set to 0,1,0 respectively. It can also be set up by the MODE key through the status line. In this mode, the user can provide screen editing and text modification using the buffered block editing feature. In the conversational mode, if an error is made when entering a line, the line must be repeated or correction characters must be sent to the host computer. With buffered block editing, the user can enter and compose a block of data and make as many corrections or changes as necessary until the text appears to be satisfactory. It can then be sent to the host at full transmission speed as clean copy. The host does not see either the line composition or editing activity. Furthermore, the host facilities are not used in the editing activity, other than terminal-host interface time.

A block transfer can be either a line (ie, up to 80 characters), a page (ie, a full screen, up to 1920 characters) or a partial page. A partial page is a predefined portion of the displayed text. The text portion is defined by ESCape codes at the start and end of the defined text.

RS-232C Handshaking. In this mode, the data terminal ready (DTR) signal is normally asserted. The request to send (RTS) is de-asserted until a block transmission is initiated. Then RTS is asserted. Following completion of a block transmission, RTS is de-asserted.

Data Flow in BLK. Data from the keyboard and host are sent to the display. Any terminal control codes or ESCape sequences are acted upon. Data is not sent to

the host until the

SEND
ENTER

 key (ie,

SHIFT	ENTER
-------	-------

) is pressed.

Data Transmission. Data can be sent in any of the following three formats: Line, Page or Partial Page.

Line Format. The code for this format sends all unprotected data on a line. The code also sends field delimiters in place of protected fields unless the transmission of guarded areas is set up. In this case, protected fields are sent. An end of text character is also sent at the conclusion of transmission of the line. Refer to Figure 4-1.

Page Format. The code for this format sends all unprotected data on a page (ie, scrolling region). The code also sends field delimiters in place of protected fields unless the transmission of guarded areas is set up. In this case, protected fields are sent. The code also sends a line delimiter at the end of each line and an end of text character at the conclusion of transmission of the page. Refer to Figure 4-1.

Partial Page Format. The code for this format sends all unprotected data which has been bracketed by STX (start) and ETX (end) codes displayed on a page. After the data has been sent, the terminal positions the cursor at the ETX code. If the page contains no STX codes, transmission begins from Home (ie, R=01, C=01). If the page contains no ETX code, the terminal sends to the end of the page and then positions the cursor at the beginning of the last line that was transmitted. If the page contains neither an STX code nor an ETX code, the entire page will be sent. If the transmission of guarded areas has been set up, protected fields will be sent. Refer to Figure 4-1.

Transmission of a Guarded Area. This may be selected by an ESCape sequence. The code causes all protected fields to be included in the block transmission. They are delimited by start-protected field and end-protected field codes. Refer to Figure 4-1. If this format is not set, field delimiters are sent in place of the protected field.

Transmission Delimiters. These codes are used in the BLK mode to define specific boundaries during transmission. See Figure 4-2.

COMMUNICATION COMMANDS

Figure 4-1 shows the ESCape sequences associated with data transmission.

ESC [SHIFT ? 1 0 I

Enter conversational mode.

ESC [SHIFT ? 1 0 h

Enter block edit mode.

ESC [SHIFT ? 1 4 h

Enter immediate transmission mode (ie, when the  key is pressed, the data is sent immediately).

ESC [SHIFT ? 1 4 I

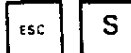
Enter deferred transmission mode. When the  key is pressed,  is transmitted automatically to alert the host that the terminal is ready to transmit. No further transmission occurs until the terminal receives ESC 5 from the host.

ESC [1 h

This sequence causes unprotected data only to be transmitted.

ESC [1 I

This sequence causes all data to be sent (ie, transmit guarded area code).

ESC SHIFT F

This sequence inserts an STX character at the cursor location to indicate the beginning of a data transmission string.

ESC SHIFT G

This sequence inserts an ETX character at the cursor location to indicate the end of a data transmission string.

ESC 5

This sequence can be invoked by the host at any time to cause a data block to be sent from the terminal to the host. The same sequence can be originated at the terminal by pressing



if immediate transmission mode is

enabled.

Figure 4-1 Communication Commands

Transmit Modes

ESC [SHIFT ? 1 1 h

This sequence sets the terminal to transmit a single line.

ESC [SHIFT ? 1 1 |

This sequence requires one of the following two sequences to initiate the mode. It sets the terminal to the page-transmission format.

ESC [1 6 h

This follow-on sequence sets the terminal to the full page transmission format including data in the fixed and scrolling window sections.

ESC [1 6 |

This follow-on sequence sets the terminal to the partial page transmission format in which only data within the scrolling window is sent.

Figure 4-1 Communication Commands (Cont)

ESC [SHIFT ? * m /

where:

- * = 0 ...Fields
- 1 ...Line
- 2 ...Start protected field
- 3 ...End protected field
- 4 ...End of text

/ = any standard ASCII or control character

Figure 4-2 Transmission Delimiter Programming

BLK	Block Mode
CR	Carriage return. Turn-around code, half duplex (HDX) mode (ASCII)
CTS	Clear to Send (RS232C handshaking status)
DCE	Data Communications Equipment
Dip switches	This is a group of 32 miniature switches which permit various operation parameters and modes to be set into the terminal. The settings are in effect when the terminal is powered up or following reset. They also introduce default parameters when no other parameter has been established.
DSR	Data Set Ready (RS232C handshaking status)
DTE	Data Terminal Equipment
DTR	Data Terminal Ready (RS232C handshaking status)
ECH	Echo Mode
EOT	End of transmission. Turn around code, half duplex (HDX) mode (ASCII)
Escape Sequences	Command strings
ETX	Transmission code (end text), in EDIT BLK mode. Turn-around code, half duplex (HDX) mode (ASCII)
FDX	Full Duplex
HDX	Half Duplex
Host computer	The host is connected to the SERIAL DATA connector (RS232C DTE).
LOC	Local Mode
RTS	Request to Send (RS232C handshaking status)
Serial data port	See host computer
Serial peripheral port	Peripheral equipment such as a line printer may be connected through this port designated RS232C DCE
STX	Transmission code (start text)
Status line	This is a display of parameters, across row 24, which are currently in effect
SUP TX	Supervisory transmit output (RS232C handshaking status)

APPENDIX 2 ASCII CODE CHART

					BIT 7	0	0	0	0	1	1	1	1
					BIT 6	0	0	1	1	0	0	1	1
					BIT 5	0	1	0	1	0	1	0	1
BIT 4	BIT 3	BIT 2	BIT 1	COL ROW	0	1	2	3	4	5	6	7	
0	0	0	0	0	NUL	DLE	SP	0	@	P	`	p	
0	0	0	1	1	SOH	DC1	!	1	A	Q	a	q	
0	0	1	0	2	STX	DC2	"	2	B	R	b	r	
0	0	1	1	3	ETX	DC3	#	3	C	S	c	s	
0	1	0	0	4	EOT	DC4	\$	4	D	T	d	t	
0	1	0	1	5	ENQ	NAK	%	5	E	U	e	u	
0	1	1	0	6	ACK	SYN	&	6	F	V	f	v	
0	1	1	1	7	BEL	ETB	'	7	G	W	g	w	
1	0	0	0	8	BS	CAN	(8	H	X	h	x	
1	0	0	1	9	HT	EM)	9	I	Y	i	y	
1	0	1	0	A	LF	SUB	*	:	J	Z	j	z	
1	0	1	1	B	VT	ESC	+	;	K	[k	{	
1	1	0	0	C	FF	FS	,	<	L	\	l		
1	1	0	1	D	CR	GS	-	=	M]	m	}	
1	1	1	0	E	SO	RS	.	>	N	^	n	~	
1	1	1	1	F	SI	US	/	?	O	_	o	DEL	

U.K. version uses £ in Column 2 Row 3 in place of #

Application Keypad Mode (Figure 3-6)	3-8
Arrangement	3-1
Audible Feedback	3-17
Block Editing Modes	3-22
Block (BLK) Mode	4-4
Character Attributes	3-17
Character Attributes (Figure 3-15)	3-18
Character Presentation On Screen	3-17
Audible Feedback	3-17
Character Set Selection	3-17
Character Attributes	3-17
Character Width Functions	3-17
Screen Background	3-17
Character Set Selection	3-17
Character Width Functions	3-17
Communication Commands	4-4
Communication Commands (Figure 4-1)	4-5
Communications Mode (Figure 3-9)	3-12
Communication Modes	4-1
Operation Modes	4-1
Conversational Control Functions	4-1
Transmission Control Codes	4-1
Interrogation Codes	4-2
Full Duplex (FDX) Mode	4-2
Half Duplex (HDX) Mode	4-3
Local (LOC) Mode	4-3
Block (BLK) Mode	4-4
Communication Commands	4-4
Cursor Control (Figure 3-16)	3-19
Cursor Control	3-17
Page Records	3-21
Cursor Position Indicator	3-21
Cursor Position Reporting	3-21
Cursor Position Indicator	3-21
Cursor Position Reporting	3-21
Deletion Keys and Sequences (Figure 3-19)	3-24
Description of Key Functions (Figure 3-3)	3-5
Dip-Switch Settings (Figure 3-2)	3-3
Dip-Switches	3-1
Dual-Function Keypad	1-4
Edit and Insert Mode (Figure 3-8)	3-11
Editing Keys (Figure 3-18)	3-22
Editing Modes	3-22
Block Editing Modes	3-22
ESCAPE Codes which Define G0 and G1 (Figure 3-14)	3-18
Full Duplex (FDX) Mode	4-2
Functional Description	1-1
GENERAL INFORMATION	1-1
GLOSSARY OF TERMS	5-1
Graphics Mode (Figure 3-10)	3-13
Half Duplex (HDX) Mode	4-3

HOW TO BEGIN	2-1
How to Use the Manual	1-1
Initial Inspection	2-1
Installation	2-1
Interrogation Codes	4-2
Introduction	1-1
Key Functions	3-1
Keyboard Layout (Figure 1-1)	1-5
Local (LOC) Mode	4-3
Main Keyboard	1-4
Monitor Mode (Figure 3-11)	3-15
NABU3100 Specifications, Interface Cables and Options (Table 1-1)	1-2
Operating Procedures	3-4
Start-Up	3-4
Status Line Access	3-4
Operating Switches and Control (Figure 3-1)	3-2
Operating Switches and Control	3-1
Power On-Off Switch	3-1
Dip-Switches	3-1
Operation Modes	4-1
Optional Features	1-4
Page and Cursor Position Indicator (Figure 3-17)	3-21
Page Records	3-21
Power On-Off Switch	3-1
PROGRAMMER NOTES	4-1
Protected Field Mode (Figure 3-7)	3-10
Purpose of Terminal	1-1
Rear Panel, Video Terminal, Input Output Connections (Figure 2-1)	2-2
Receive (RX) and Transmit (TX) Speeds (Figure 3-12)	3-16
RS232C Parameters	4-1
RS232C Pin Assignments for Host Port (Table 2-1)	2-1
Scope and Arrangement	1-1
Screen Alignment Display	3-26
Screen Background	3-17
Scrolling Region (Split Screen)	3-25
Set-Up Mode (Figure 3-5)	3-7
Set-Up Parameters (Table 3-1)	3-7
Standard Features	1-1
Start-Up	3-4
Status Line Access	3-4
Status Line Display	3-4
Status Line Set-Up Mode	3-7
Status Line Format (Figure 3-4)	3-6
Status Line Set-Up Mode	3-7
Status Reset (Figure 3-13)	3-16
Tab Function Escape Codes	3-25
Tab Functions	3-25
Tab Function Escape Codes	3-25
Terminal Components	1-4
Main Keyboard	1-4
Dual-Function Keypad	1-4
Video Display Screen	1-4
Transmission Control Codes	4-1
Transmission Delimiter Programming (Figure 4-2)	4-6
USER NOTES	3-1
User String (US) Keys	3-25
Video Display Screen	1-4