



8203 64K DYNAMIC RAM CONTROLLER

- Provides All Signals Necessary to Control 64K and 16K Dynamic Memories
- Directly Addresses and Drives Up to 64 Devices Without External Drivers
- Provides Address Multiplexing and Strobes
- Provides a Refresh Timer and a Refresh Counter
- Provides Refresh/Access Arbitration
- Internal Clock Capability with the 8203-1 and the 8203-3
- Fully Compatible with Intel® 8080A, 8085A, iAPX88, and iAPX 86 Family Microprocessors
- Decodes CPU Status for Advanced Read Capability in 16K Mode with the 8203-1 and the 8203-3.
- Provides System Acknowledge and Transfer Acknowledge Signals
- Refresh Cycles May be Internally or Externally Requested (For Transparent Refresh)
- Internal Series Damping Resistors on All RAM Outputs

The Intel® 8203 is a Dynamic RAM System Controller designed to provide all signals necessary to use 64K or 16K Dynamic RAMs in microcomputer systems. The 8203 provides multiplexed addresses and address strobes, refresh logic, refresh/access arbitration. Refresh cycles can be started internally or externally. The 8203-1 and the 8203-3 support an internal crystal oscillator and Advanced Read Capability. The 8203-3 is a $\pm 5\%$ V_{CC} part.

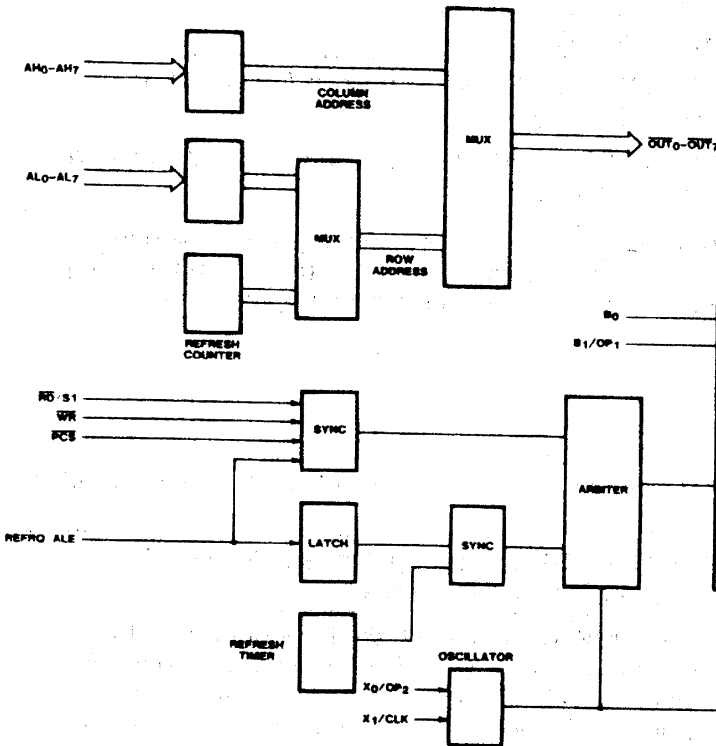
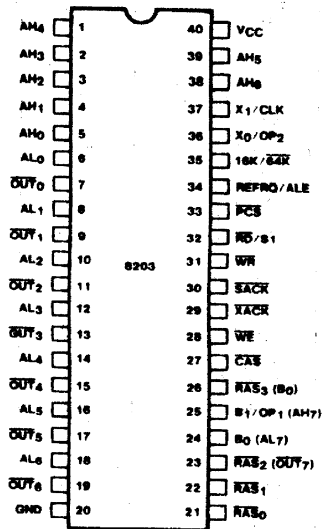

Figure 1. 8203 Block Diagram

210444-1



210444-2
Figure 2.
Pin Configuration

Table 1. Pin Descriptions

Symbol	Pin No.	Type	Name and Function
AL ₀ AL ₁ AL ₂ AL ₃ AL ₄ AL ₅ AL ₆	6 8 10 12 14 16 18	 	ADDRESS LOW: CPU address inputs used to generate memory row address.
AH ₀ AH ₁ AH ₂ AH ₃ AH ₄ AH ₅ AH ₆	5 4 3 2 1 39 38	 	ADDRESS HIGH: CPU address inputs used to generate memory column address.
B ₀ /AL ₇ B ₁ /OP ₁ / AH ₇	24 25	 	BANK SELECT INPUTS: Used to gate the appropriate $\overline{\text{RAS}}$ output for a memory cycle. B ₁ /OP ₁ option used to select the Advanced Read Mode. (Not available in 64K mode.) See Figure 5. When in 64K RAM Mode, pins 24 and 25 operate as the AL ₇ and AH ₇ address inputs.
$\overline{\text{PCS}}$	33		PROTECTED CHIP SELECT: Used to enable the memory read and write inputs. Once a cycle is started, it will not abort even if $\overline{\text{PCS}}$ goes inactive before cycle completion.
$\overline{\text{WR}}$	31		MEMORY WRITE REQUEST.
$\overline{\text{RD}}/\text{S1}$	32		MEMORY READ REQUEST: S1 function used in Advanced Read mode selected by OP ₁ (pin 25).
REFRQ/ ALE	34		EXTERNAL REFRESH REQUEST: ALE function used in Advanced Read mode, selected by OP ₁ (pin 25).
$\overline{\text{OUT}}_0$ $\overline{\text{OUT}}_1$ $\overline{\text{OUT}}_2$ $\overline{\text{OUT}}_3$ $\overline{\text{OUT}}_4$ $\overline{\text{OUT}}_5$ $\overline{\text{OUT}}_6$	7 9 11 13 15 17 19	O O O O O O O	OUTPUT OF THE MULTIPLEXER: These outputs are designed to drive the addresses of the Dynamic RAM array. (Note that the $\overline{\text{OUT}}_{0-7}$ pins do not require inverters or drivers for proper operation.)
$\overline{\text{WE}}$	28	O	WRITE ENABLE: Drives the Write Enable inputs of the Dynamic RAM array.
$\overline{\text{CAS}}$	27	O	COLUMN ADDRESS STROBE: This output is used to latch the Column Address into the Dynamic RAM array.
$\overline{\text{RAS}}_0$ $\overline{\text{RAS}}_1$ $\overline{\text{RAS}}_2$ / $\overline{\text{OUT}}_7$ $\overline{\text{RAS}}_3/\text{B}_0$	21 22 23 26	O O O I/O	ROW ADDRESS STROBE: Used to latch the Row Address into the bank of dynamic RAMs, selected by the 8203 Bank Select pins (B ₀ , B ₁ /OP ₁). In 64K mode, only $\overline{\text{RAS}}_0$ and $\overline{\text{RAS}}_1$ are available; pin 23 operates as $\overline{\text{OUT}}_7$ and pin 26 operates as the B ₀ bank select input.
$\overline{\text{XACK}}$	29	O	TRANSFER ACKNOWLEDGE: This output is a strobe indicating valid data during a read cycle or data written during a write cycle. $\overline{\text{XACK}}$ can be used to latch valid data from the RAM array.

Table 1. Pin Descriptions (Continued)

Symbol	Pin No.	Type	Name and Function
$\overline{\text{SACK}}$	30	O	SYSTEM ACKNOWLEDGE: This output indicates the beginning of a memory access cycle. It can be used as an advanced transfer acknowledge to eliminate wait states. (Note: If a memory access request is made during a refresh cycle, $\overline{\text{SACK}}$ is delayed until $\overline{\text{XACK}}$ in the memory access cycle).
X_0/OP_2 X_1/CLK	36 37	I/O I/O	OSCILLATOR INPUTS: These inputs are designed for a quartz crystal to control the frequency of the oscillator. If X_0/OP_2 is shorted to pin 40 (V_{CC}) or if X_0/OP_2 is connected to +12V through a 1 K Ω resistor then X_1/CLK becomes a TTL input for an external clock. (Note: Crystal mode for the 8203-1 and the 8203-3 only).
16K/64K	35	I	MODE SELECT: This input selects 16K mode or 64K mode. Pins 23–26 change function based on the mode of operation.
V_{CC}	40		POWER SUPPLY: +5V.
GND	20		GROUND.

FUNCTIONAL DESCRIPTION

The 8203 provides a complete dynamic RAM controller for microprocessor systems as well as expansion memory boards.

The 8203 has two modes, one for 16K dynamic RAMs and one for 64Ks, controlled by pin 35.

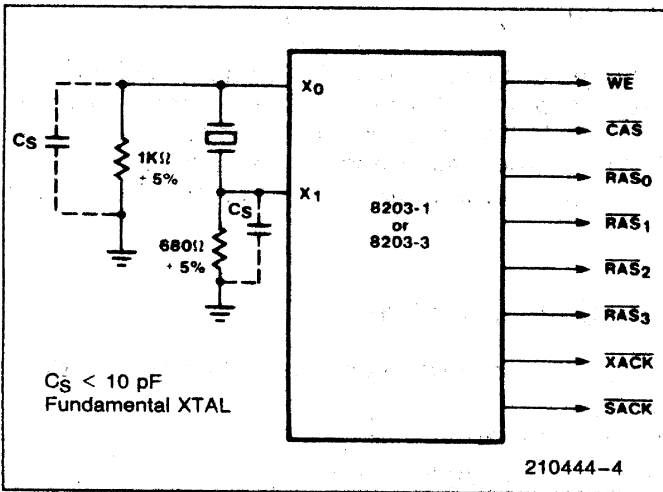

Figure 3. Crystal Operation for the 8203-1 and 8203-3

All 8203 timing is generated from a single reference clock. This clock is provided via an external oscillator or an on-chip crystal oscillator. All output signal

transitions are synchronous with respect to this clock reference, except for the trailing edges of the CPU handshake signals $\overline{\text{SACK}}$ and $\overline{\text{XACK}}$.

CPU memory requests normally use the $\overline{\text{RD}}$ and $\overline{\text{WR}}$ inputs. The Advanced-Read mode allows ALE and S1 to be used in place of the $\overline{\text{RD}}$ input.

Failsafe refresh is provided via an internal timer which generates refresh requests. Refresh requests can also be generated via the REFRQ input.

An on-chip synchronizer/arbitrator prevents memory and refresh requests from affecting a cycle in progress. The READ, WRITE, and external REFRESH requests may be asynchronous to the 8203 clock; on-chip logic will synchronize the requests, and the arbitrator will decide if the requests should be delayed, pending completion of a cycle in progress.

16K/64 Option Selection

Pin 35 is a strap input that controls the two 8203 modes. Figure 4 shows the four pins that are multiplexed. In 16K mode (pin 35 tied to V_{CC} or left open), the 8203 has two Bank Select inputs to select one of four $\overline{\text{RAS}}$ outputs. In this mode, the 8203 is exactly compatible with the Intel 8202A Dynamic RAM Controller. In 64K mode (pin 35 tied to GND), there is only one Bank Select input (pin 26) to select the two $\overline{\text{RAS}}$ outputs. More than two banks of 64K dynamic RAMs can be used with external logic.

Other Option Selections

The 8203 has two strapping options. When OP₁ is selected (16K mode only), pin 32 changes from a \overline{RD} input to an S1 input, and pin 34 changes from a REFRQ input to an ALE input. See "Refresh Cycles" and "Read Cycles" for more detail. OP₁ is selected by tying pin 25 to +12V through a 5.1 K Ω resistor on the 8203-1 or 8203-3 only.

When OP₂ is selected, the internal oscillator is disabled and pin 37 changes from a crystal input (X₁) to a CLK input for an external TTL clock. OP₂ is selected by shorting pin 36 (X₀/OP₂) directly to pin 40 (V_{CC}). No current limiting resistor should be used. OP₂ may also be selected by tying pin 36 to +12V through a 1 K Ω resistor.

Refresh Timer

The refresh timer is used to monitor the time since the last refresh cycle occurred. When the appropriate amount of time has elapsed, the refresh timer will request a refresh cycle. External refresh requests will reset the refresh timer.

Refresh Counter

The refresh counter is used to sequentially refresh all of the memory's rows. The 8-bit counter is incremented after every refresh cycle.

Pin #	16K Function	64K Function
23	\overline{RAS}_2	Address Output (\overline{OUT}_7)
24	Bank Select (B ₀)	Address Input (AL ₇)
25	Bank Select (B ₁)	Address Input (AH ₇)
26	\overline{RAS}_3	Bank Select (B ₀)

Figure 4. 16K/64K Mode Selection

	Inputs		Outputs			
	B ₁	B ₀	RAS ₀	RAS ₁	RAS ₂	RAS ₃
16K Mode	0	0	0	1	1	1
	0	1	1	0	1	1
	1	0	1	1	0	1
	1	1	1	1	1	0
64K Mode	—	0	0	1	—	—
	—	1	1	0	—	—

Figure 5. Bank Selection

Description	Pin #	Normal Function	Option Function
B ₁ /OP ₁ (16K only)/AH ₇	25	Bank (\overline{RAS}) Select	Advanced-Read Mode (8203-1, -3)
X ₀ /OP ₂	36	Crystal Oscillator (8203-1 and 8203-3)	External Oscillator

Figure 6. 8203 Option Selection

Address Multiplexer

The address multiplexer takes the address inputs and the refresh counter outputs, and gates them onto the address outputs at the appropriate time. The address outputs, in conjunction with the \overline{RAS} and \overline{CAS} outputs, determine the address used by the dynamic RAMs for read, write, and refresh cycles. During the first part of a read or write cycle, AL₀-AL₇ are gated to \overline{OUT}_0 - \overline{OUT}_7 , then AH₀-AH₇ are gated to the address outputs.

During a refresh cycle, the refresh counter is gated onto the address outputs. All refresh cycles are \overline{RAS} -only refresh (\overline{CAS} inactive, \overline{RAS} active).

To minimize buffer delay, the information on the address outputs is inverted from that on the address inputs.

\overline{OUT}_0 - \overline{OUT}_7 do not need inverters or buffers unless additional drive is required.

Synchronizer/Arbiter

The 8203 has three inputs, REFRQ/ALE (pin 34), \overline{RD} (pin 32) and \overline{WR} (pin 31). The \overline{RD} and \overline{WR} inputs allow an external CPU to request a memory read or write cycle, respectively. The REFRQ/ALE input allows refresh requests to be requested external to the 8203.

All three of these inputs may be asynchronous with respect to the 8203's clock. The arbiter will resolve conflicts between refresh and memory requests, for both pending cycles and cycles in progress. Read and write requests will be given priority over refresh requests.

System Operation

The 8203 is always in one of the following states:

- a) IDLE
- b) TEST Cycle
- c) REFRESH Cycle
- d) READ Cycle
- e) WRITE Cycle

The 8203 is normally in the IDLE state. Whenever one of the other cycles is requested, the 8203 will

leave the IDLE state to perform the desired cycle. If no other cycles are pending, the 8203 will return to the IDLE state.

Test Cycle

The TEST Cycle is used to check operation of several 8203 internal functions. TEST cycles are requested by activating the PCS, RD and WR inputs. The TEST Cycle will reset the refresh address counter and perform a WRITE Cycle. The TEST Cycle should not be used in normal system operation, since it would affect the dynamic RAM refresh.

Refresh Cycles

The 8203 has two ways of providing dynamic RAM refresh:

- 1) Internal (failsafe) refresh
- 2) External (hidden) refresh

Both types of 8203 refresh cycles activate all of the RAS outputs, while CAS, WE, SACK, and XACK remain inactive.

Internal refresh is generated by the on-chip refresh timer. The timer uses the 8203 clock to ensure that refresh of all rows of the dynamic RAM occurs every 2 milliseconds (128 cycles) or every 4 milliseconds (256 cycles). If REFRQ is inactive, the refresh timer will request a refresh cycle every 10–16 microseconds.

External refresh is requested via the REFRQ input (pin 34). External refresh control is not available when the Advanced-Read mode is selected. External refresh requests are latched, then synchronized to the 8203 clock.

The arbiter will allow the refresh request to start a refresh cycle only if the 8203 is not in the middle of a cycle.

When the 8203 is in the idle state a simultaneous memory request and external refresh request will result in the memory request being honored first. This 8203 characteristic can be used to "hide" refresh cycles during system operation. A circuit similar to Figure 7 can be used to decode the CPU's instruction fetch status to generate an external refresh request. The refresh request is latched while the 8203 performs the instruction fetch; the refresh cycle will start immediately after the memory cycle is completed, even if the RD input has not gone inactive. If the CPU's instruction decode time is long enough, the 8203 can complete the refresh cycle before the next memory request is generated.

If the 8203 is not in the idle state then a simultaneous memory request and an external refresh request may result in the refresh request being honored first.

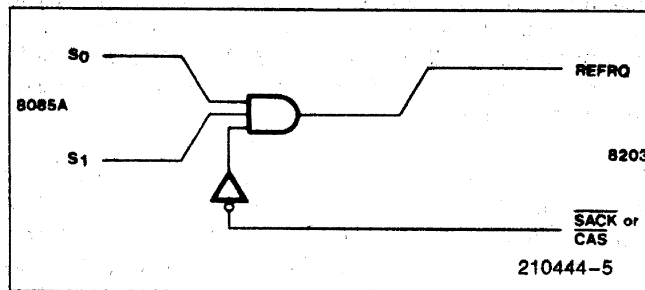

Figure 7. Hidden Refresh

Certain system configurations require complete external refresh requests. If external refresh is requested faster than the minimum internal refresh timer (t_{REF}), then, in effect, all refresh cycles will be caused by the external refresh request, and the internal refresh timer will never generate a refresh request.

Read Cycles

The 8203 can accept two different types of memory Read requests:

- 1) Normal Read, via the RD input
- 2) Advanced Read, using the S1 and ALE inputs (16K mode only)

The user can select the desired Read request configuration via the B₁/OP₁ hardware strapping option on pin 25.

	Normal Read	Advanced Read
Pin 25	B ₁ Input	OP ₁ (+12V)
Pin 32	RD Input	S1 Input
Pin 34	REFRQ Input	ALE Input
# RAM Banks	4 (RAS ₀₋₃)	2 (RAS ₂₋₃)
Ext. Refresh	Yes	No

Figure 8. 8203 Read Options

Normal Reads are requested by activating the RD input, and keeping it active until the 8203 responds with an XACK pulse. The RD input can go inactive as soon as the command hold time (t_{CHS}) is met.

Advanced Read cycles are requested by pulsing ALE while S1 is active; if S1 is inactive (low) ALE is ignored. Advanced Read timing is similar to Normal Read timing, except the falling edge of ALE is used as the cycle start reference.

If a Read cycle is requested while a refresh cycle is in progress, then the 8203 will set the internal delayed-SACK latch. When the Read cycle is eventually started, the 8203 will delay the active SACK transition until XACK goes active, as shown in the A.C. timing diagrams. This delay was designed to compensate for the CPU's READY setup and hold times. The delayed-SACK latch is cleared after every READ cycle.

Based on system requirements, either SACK or XACK can be used to generate the CPU READY signal. XACK will normally be used; if the CPU can tolerate an advanced READY, then SACK can be used, but only if the CPU can tolerate the amount of advance provided by SACK. If SACK arrives too early to provide the appropriate number of WAIT states, then either XACK or a delayed form of SACK should be used.

Write Cycles

Write cycles are similar to Normal Read cycles, except for the WE output. WE is held inactive for Read cycles, but goes active for Write cycles. All 8203 Write cycles are "early-write" cycles; WE goes active before CAS goes active by an amount of time sufficient to keep the dynamic RAM output buffers turned off.

General System Considerations

All memory requests (Normal Reads, Advanced Reads, Writes) are qualified by the PCS input. PCS should be stable, either active or inactive, prior to the leading edge of RD, WR, or ALE. Systems which use battery backup should pullup PCS to prevent erroneous memory requests.

In order to minimize propagation delay, the 8203 uses an inverting address multiplexer without latches. The system must provide adequate address setup and hold times to guarantee RAS and CAS setup and hold times for the RAM. The t_{AD} A.C. parameter should be used for this system calculation.

The B₀-B₁ inputs are similar to the address inputs in that they are not latched. B₀ and B₁ should not be changed during a memory cycle, since they directly control which RAS output is activated.

The 8203 uses a two-stage synchronizer for the memory request inputs (RD, WR, ALE), and a separate two stage synchronizer for the external refresh input (REFRQ). As with any synchronizer, there is always a finite probability of metastable states inducing system errors. The 8203 synchronizer was

designed to have a system error rate less than 1 memory cycle every three years based on the full operating range of the 8203.

A microprocessor system is concerned when the data is valid after RD goes low. See Figure 9. In order to calculate memory read access times, the dynamic RAM's A.C. specifications must be examined, especially the RAS-access time (t_{RAC}) and the CAS-access time (t_{CAC}). Most configurations will be CAS-access limited; i.e., the data from the RAM will be stable t_{CC,max} (8203) + t_{CAC} (RAM) after a memory read cycle is started. Be sure to add any delays (due to buffers, data latches, etc.) to calculate the overall read access time.

Since the 8203 normally performs "early-write" cycles, the data must be stable at the RAM data inputs by the time CAS goes active, including the RAM's data setup time. If the system does not normally guarantee sufficient write data setup, you must either delay the WR input signal or delay the 8203 WE output.

Delaying the WR input will delay all 8203 timing, including the READY handshake signals, SACK and XACK, which may increase the number of WAIT states generated by the CPU.

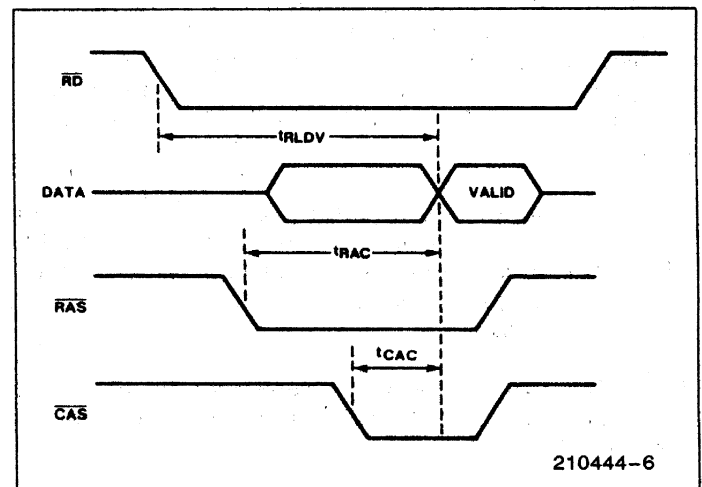

Figure 9. Read Access Time

If the WE output is externally delayed beyond the CAS active transition, then the RAM will use the falling edge of WE to strobe the write data into the RAM. This WE transition should not occur too late during the CAS active transition, or else the WE to CAS requirements of the RAM will not be met.

The RAS₀₋₃, CAS, OUT₀₋₇, and WE outputs contain on-chip series damping resistors (typically 20Ω) to minimize overshoot.

Some dynamic RAMs require more than 2.4V V_{IH} . Noise immunity may be improved for these RAMs by

adding pull-up resistors to the 8203's outputs. Intel RAMs do not require pull-up resistors.

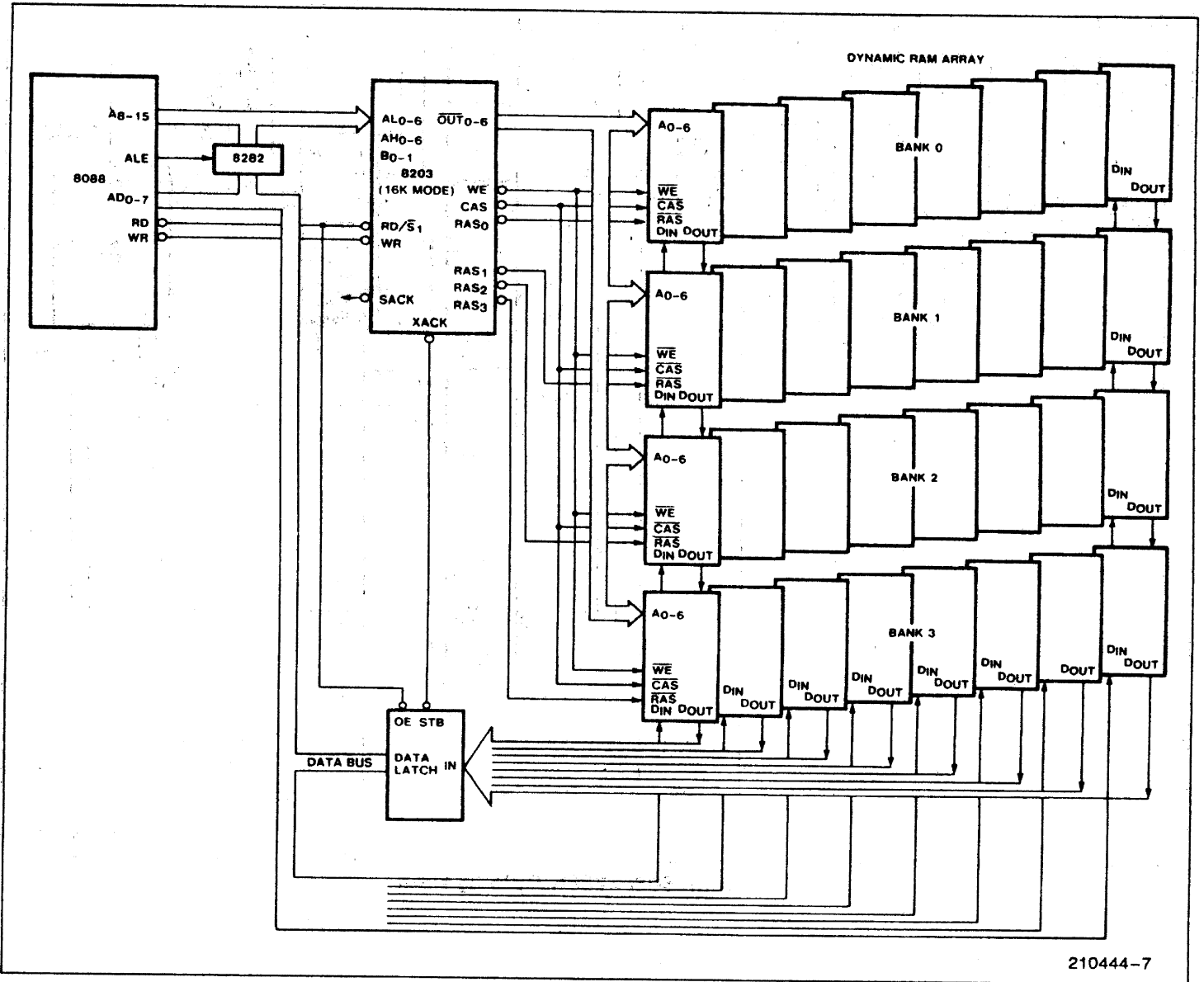
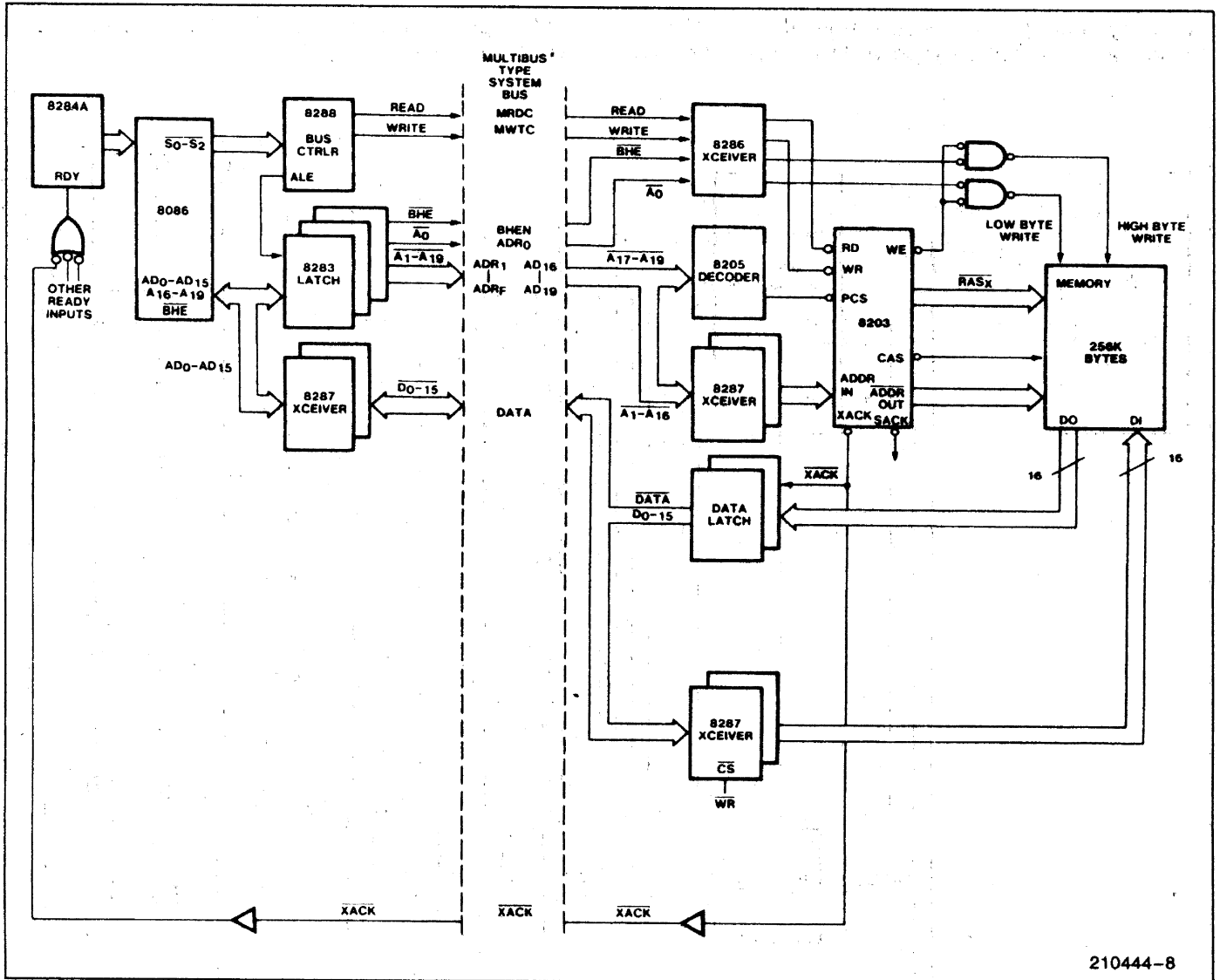

Figure 10. Typical 8088 System

210444-7



210444-8

Figure 11. 8086/256K Byte System

ABSOLUTE MAXIMUM RATINGS*

Ambient Temperature Under Bias 0°C to 70°C
 Storage Temperature -65°C to +150°C
 Voltage On Any Pin
 With Respect to Ground -0.5V to +7V
 Power Dissipation 1.6 Watts

**Notice: Stresses above those listed under "Absolute Maximum Ratings" may cause permanent damage to the device. This is a stress rating only and functional operation of the device at these or any other conditions above those indicated in the operational sections of this specification is not implied. Exposure to absolute maximum rating conditions for extended periods may affect device reliability.*

D.C. CHARACTERISTICS $T_A = 0^\circ\text{C to } 70^\circ\text{C}; V_{CC} = 5.0\text{V} \pm 10\%$ (5.0V $\pm 5\%$ for 8203-3); GND = 0V

Symbol	Parameter	Min	Max	Units	Test Conditions
V_{CC}	Input Clamp Voltage		-1.0	V	$I_C = -5\text{ mA}$
I_{CC}	Power Supply Current		290	mA	
I_F	Forward Input Current CLK, 64K/16K Mode Select All Other Inputs(3)		-2.0 -320	mA μA	$V_F = 0.45\text{V}$ $V_F = 0.45\text{V}$
I_R	Reverse Input Current(3)		40	μA	$V_R = V_{CC}(1, 5)$
V_{OL}	Output Low Voltage SACK, XACK All Other Outputs		0.45 0.45	V V	$I_{OL} = 5\text{ mA}$ $I_{OL} = 3\text{ mA}$
V_{OH}	Output High Voltage SACK, XACK All Other Outputs	2.4 2.6		V V	$V_{IL} = 0.65\text{V}$ $I_{OH} = -1\text{ mA}$ $I_{OH} = -1\text{ mA}$
V_{IL}	Input Low Voltage		0.8	V	$V_{CC} = 5.0\text{V}(2)$
V_{IH1}	Input High Voltage	2.0	V_{CC}	V	$V_{CC} = 5.0\text{V}$
V_{IH2}	Option Voltage		V_{CC}	V	(4)
C_{IN}	Input Capacitance		30	pF	$F = 1\text{ MHz}(6)$ $V_{BIAS} = 2.5\text{V}, V_{CC} = 5\text{V}$

NOTES:

- $I_R = 200\ \mu\text{A}$ for pin 37 (CLK).
- For test mode RD & WR must be held at GND.
- Except for pin 36 in XTAL mode.
- 8203-1 and 8203-3 support both OP₁ and OP₂, 8203 only supports OP₂.

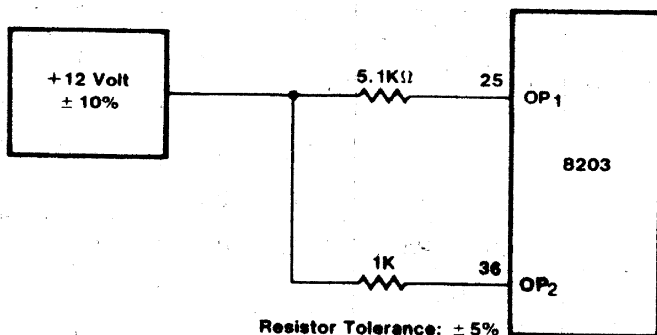

- $I_R = 150\ \mu\text{A}$ for pin 35 (Mode Select 16K/64K).
- Sampled not 100% tested, $T_A = 25^\circ\text{C}$.

210444-3

A.C. CHARACTERISTICS

$T_J = 0^\circ\text{C to } 70^\circ\text{C}$; $V_{CC} = 5\text{V} \pm 10\%$ ($5.0\text{V} \pm 5\%$ for 8203-3); $GND = 0\text{V}$
 Measurements made with respect to $\overline{\text{RAS}}_0\text{--}\overline{\text{RAS}}_3$, $\overline{\text{CAS}}$, $\overline{\text{WE}}$, $\overline{\text{OUT}}_0\text{--}\overline{\text{OUT}}_6$ are at 2.4V and 0.8V. All other pins are measured at 1.5V. All times are in ns.

Symbol	Parameter	Min	Max	Notes
t_p	Clock Period	40	54	
t_{PH}	External Clock High Time	20		
t_{PL}	External Clock Low Time—Above ($>$) 20 MHz	17		
t_{PL}	External Clock Low Time—Below (\leq) 20 MHz	20		
t_{RC}	Memory Cycle Time	$10t_p - 30$	$12t_p$	4, 5
t_{REF}	Refresh Time (128 cycles)	$264t_p$	$288t_p$	
t_{RP}	$\overline{\text{RAS}}$ Precharge Time	$4t_p - 30$		
t_{RSH}	$\overline{\text{RAS}}$ Hold After $\overline{\text{CAS}}$	$5t_p - 30$		3
t_{ASR}	Address Setup to $\overline{\text{RAS}}$	$t_p - 30$		3
t_{RAH}	Address Hold From $\overline{\text{RAS}}$	$t_p - 10$		3
t_{ASC}	Address Setup to $\overline{\text{CAS}}$	$t_p - 30$		3
t_{CAH}	Address Hold from $\overline{\text{CAS}}$	$5t_p - 20$		3
t_{CAS}	$\overline{\text{CAS}}$ Pulse Width	$5t_p - 10$		
t_{WCS}	$\overline{\text{WE}}$ Setup to $\overline{\text{CAS}}$	$t_p - 40$		
t_{WCH}	$\overline{\text{WE}}$ Hold After $\overline{\text{CAS}}$	$5t_p - 35$		8
t_{RS}	$\overline{\text{RD}}$, $\overline{\text{WR}}$, ALE, REFRQ Delay From $\overline{\text{RAS}}$	$5t_p$		2, 6
t_{MRP}	$\overline{\text{RD}}$, $\overline{\text{WR}}$ Setup to $\overline{\text{RAS}}$	0		5
t_{RMS}	REFRQ Setup to $\overline{\text{RD}}$, $\overline{\text{WR}}$	$2t_p$		6
t_{RMP}	REFRQ Setup to $\overline{\text{RAS}}$	$2t_p$		5
t_{PCS}	$\overline{\text{PCS}}$ Setup to $\overline{\text{RD}}$, $\overline{\text{WR}}$, ALE	20		
t_{AL}	S1 Setup to ALE	15		
t_{LA}	S1 Hold From ALE	30		
t_{CR}	$\overline{\text{RD}}$, $\overline{\text{WR}}$, ALE to $\overline{\text{RAS}}$ Delay	$t_p + 30$	$2t_p + 70$	2
t_{CC}	$\overline{\text{RD}}$, $\overline{\text{WR}}$, ALE to $\overline{\text{CAS}}$ Delay	$t_p + 25$	$4t_p + 85$	2
t_{SC}	CMD Setup to Clock	15		1
t_{MRS}	$\overline{\text{RD}}$, $\overline{\text{WR}}$ Setup to REFRQ	5		2
t_{CA}	$\overline{\text{RD}}$, $\overline{\text{WR}}$, ALE to $\overline{\text{SACK}}$ Delay		$2t_p + 47$	2, 9
t_{CX}	$\overline{\text{CAS}}$ to $\overline{\text{XACK}}$ Delay	$5t_p - 25$	$5t_p + 20$	
t_{CS}	$\overline{\text{CAS}}$ to $\overline{\text{SACK}}$ Delay	$5t_p - 25$	$5t_p + 40$	2, 10
t_{ACK}	$\overline{\text{XACK}}$ to $\overline{\text{CAS}}$ Setup	10		
t_{XW}	$\overline{\text{XACK}}$ Pulse Width	$t_p - 25$		7
t_{CK}	$\overline{\text{SACK}}$, $\overline{\text{XACK}}$ Turn-Off Delay		35	
t_{KCH}	CMD Inactive Hold After $\overline{\text{SACK}}$, $\overline{\text{XACK}}$	10		

A.C. CHARACTERISTICS (Continued)

$T_J = 0^\circ\text{C}$ to 70°C ; $V_{CC} = 5V \pm 10\%$ ($5.0V \pm 5\%$ for 8203-3); $GND = 0V$

Measurements made with respect to \overline{RAS}_0 - \overline{RAS}_3 , \overline{CAS} , \overline{WE} , \overline{OUT}_0 - \overline{OUT}_6 are at 2.4V and 0.8V. All other pins are measured at 1.5V. All times are in ns.

Symbol	Parameter	Min	Max	Notes
t_{LL}	REFRQ Pulse Width	20		
t_{CHS}	CMD Hold Time	30		11
t_{RFR}	REFRQ to \overline{RAS} Delay		$4t_p + 100$	6
t_{WW}	\overline{WR} to \overline{WE} Delay	0	50	8
t_{AD}	CPU Address Delay	0	40	3

NOTES:

- t_{SC} is a reference point only. ALE, \overline{RD} , \overline{WR} , and REFRQ inputs do not have to be externally synchronized to 8203 clock.
- If t_{RS} min and t_{MS} min are met then t_{CA} , t_{CR} , and t_{CC} are valid, otherwise t_{CS} is valid.
- t_{ASR} , t_{RAH} , t_{ASC} , t_{CAH} , and t_{RSH} depend upon B_0 - B_1 and CPU address remaining stable throughout the memory cycle. The address inputs are not latched by the 8203.
- For back-to-back refresh cycles, t_{RC} max = 13 t_p .
- t_{RC} max is valid only if t_{MRP} min is met (READ, WRITE followed by REFRESH) or t_{MRP} min is met (REFRESH followed by READ, WRITE).
- t_{RFR} is valid only if t_{RS} min and t_{MS} min are met.
- t_{XW} min applies when \overline{RD} , \overline{WR} has already gone high. Otherwise \overline{XACK} follows \overline{RD} , \overline{WR} .
- \overline{WE} goes high according to t_{WCH} or t_{WW} , whichever occurs first.
- t_{CA} applies only when in normal \overline{SACK} mode.
- t_{CS} applies only when in delayed \overline{SACK} mode.
- t_{CHS} must be met only to ensure a \overline{SACK} active pulse when in delayed \overline{SACK} mode. \overline{XACK} will always be activated for at least t_{XW} ($t_p - 25$ ns). Violating t_{CHS} min does not otherwise affect device operation.

WAVEFORMS

Normal Read or Write Cycle

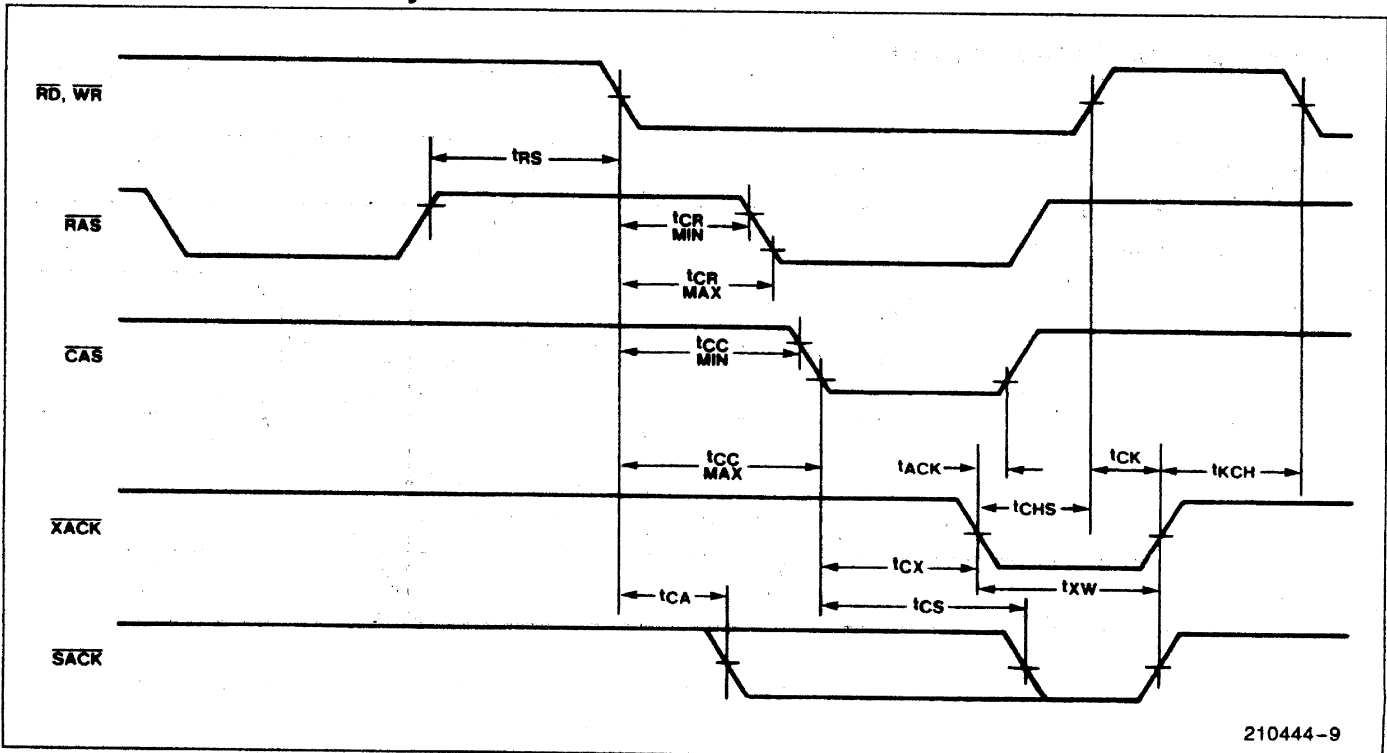

210444-9

WAVEFORMS (Continued)

Advanced Read Mode

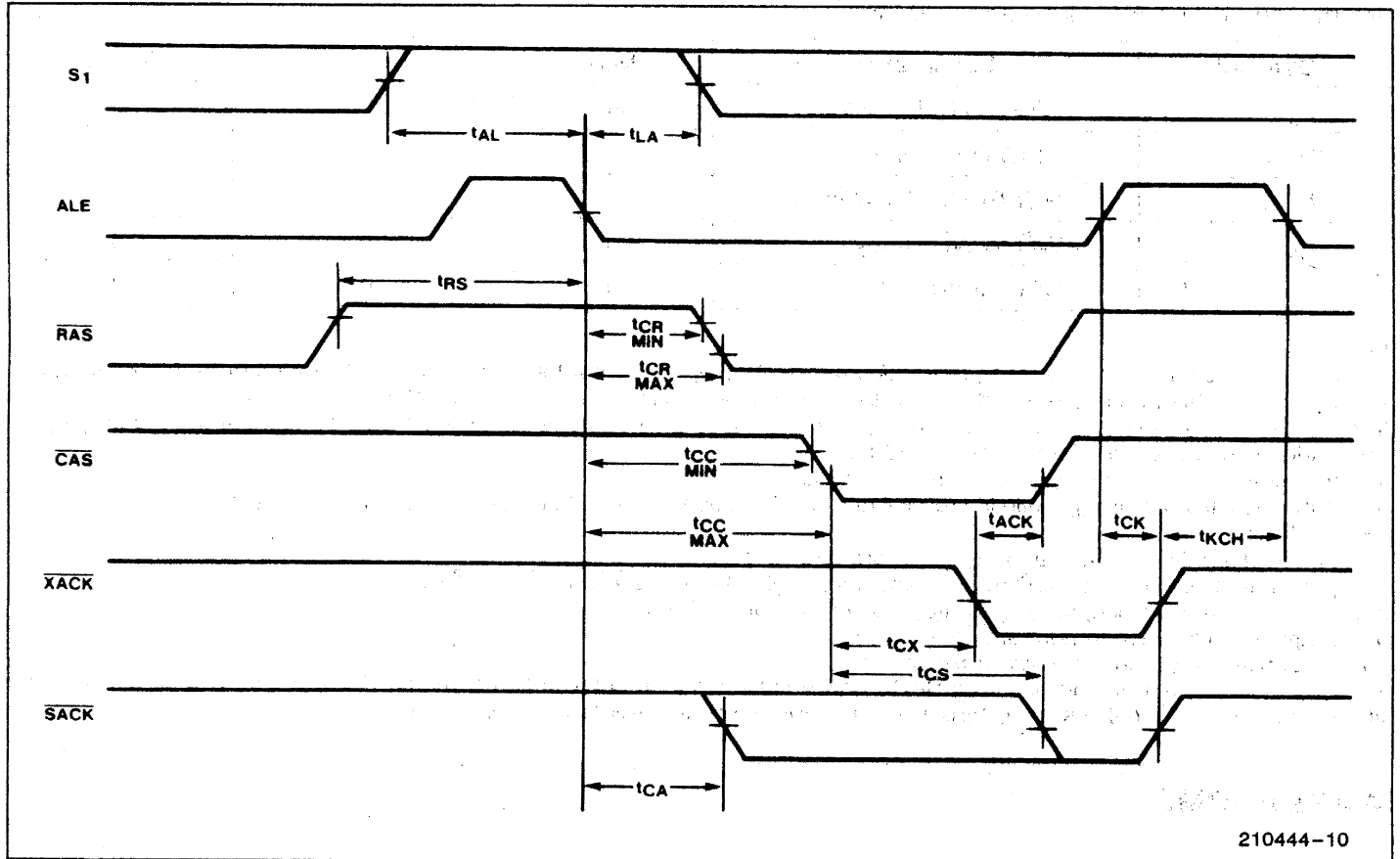

Memory Compatibility Timing

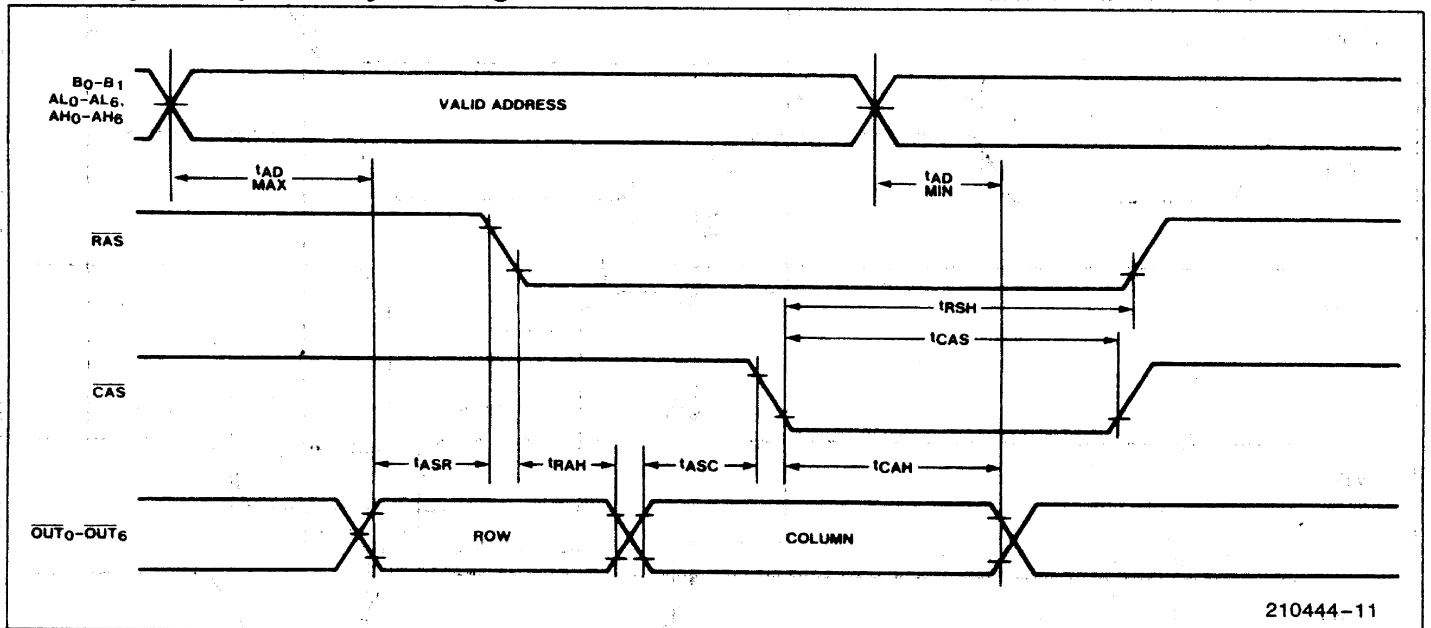

WAVEFORMS (Continued)

Write Cycle Timing

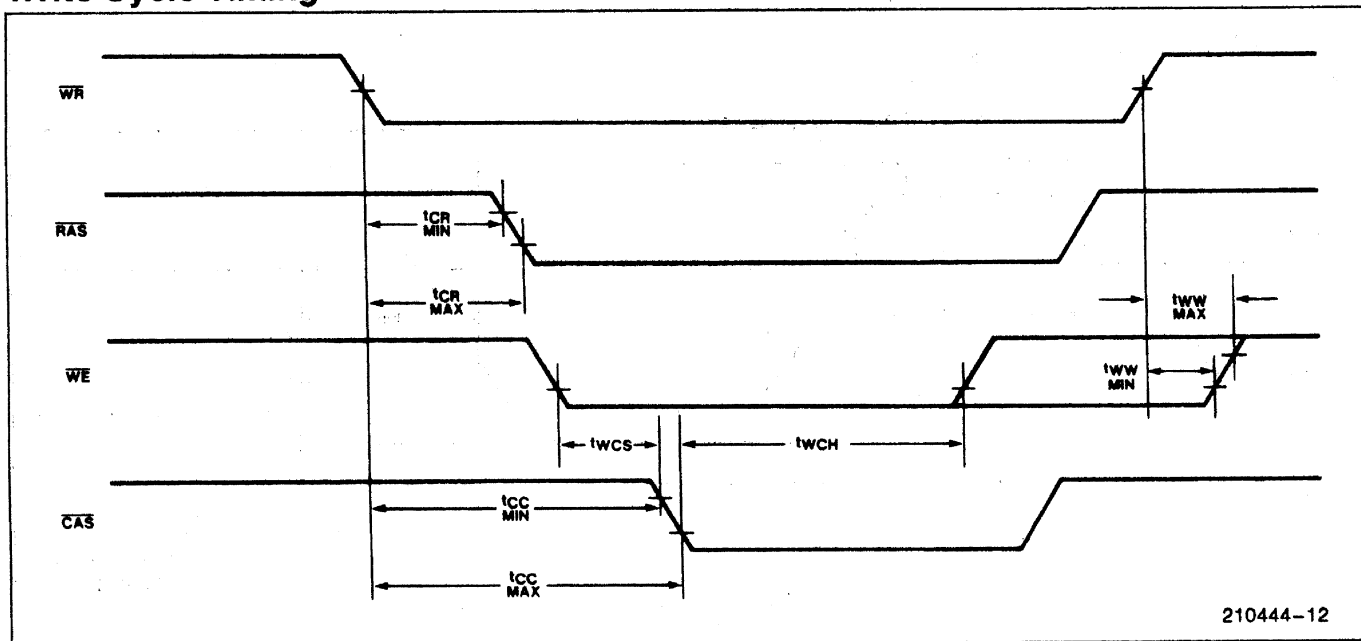

Read or Write Followed By External Refresh

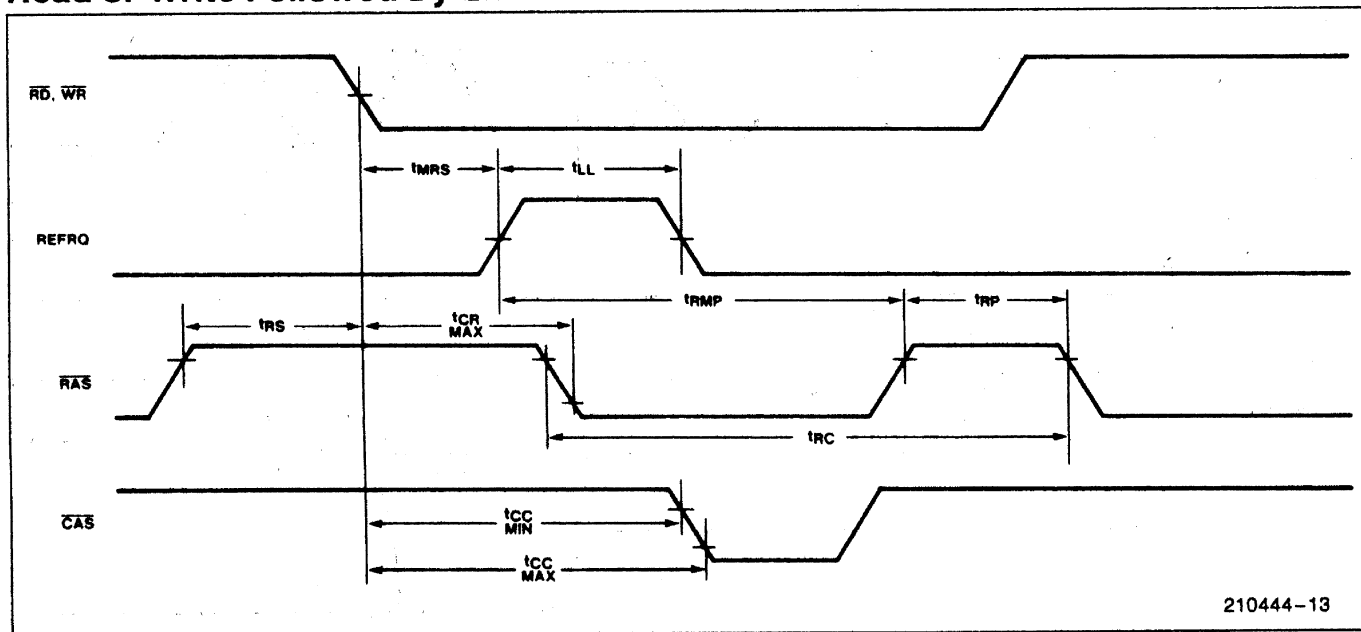

WAVEFORMS (Continued)

External Refresh Followed By Read or Write

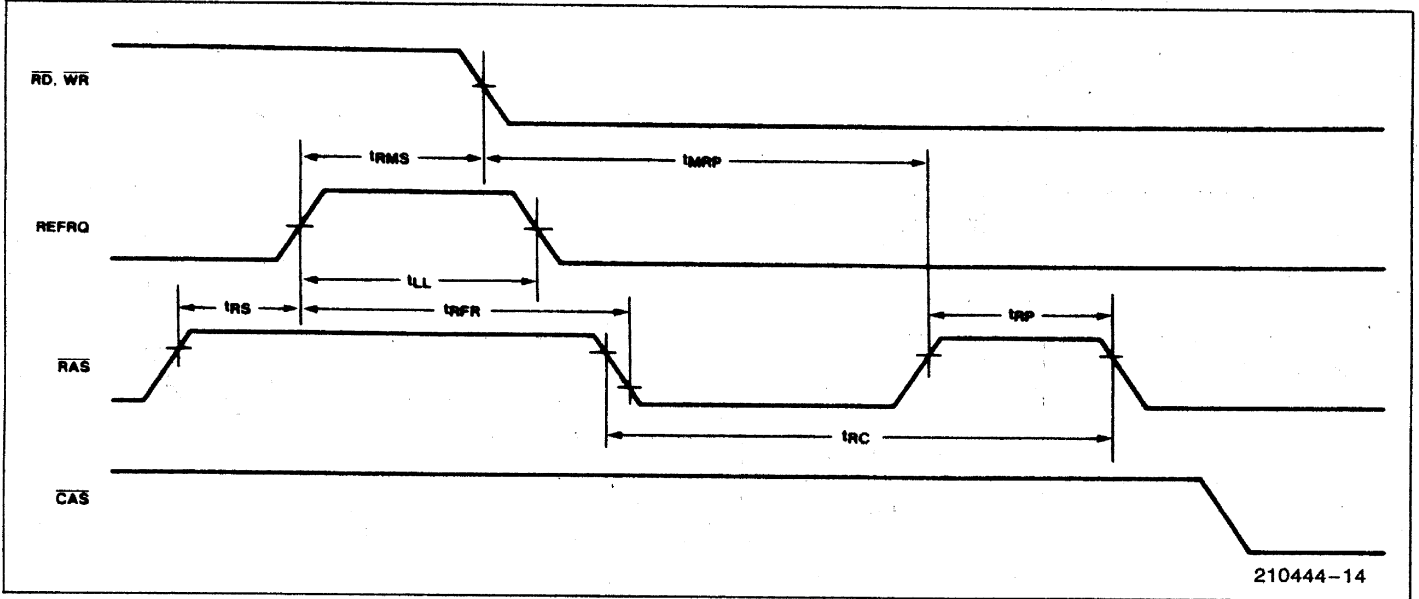

Clock and System Timing

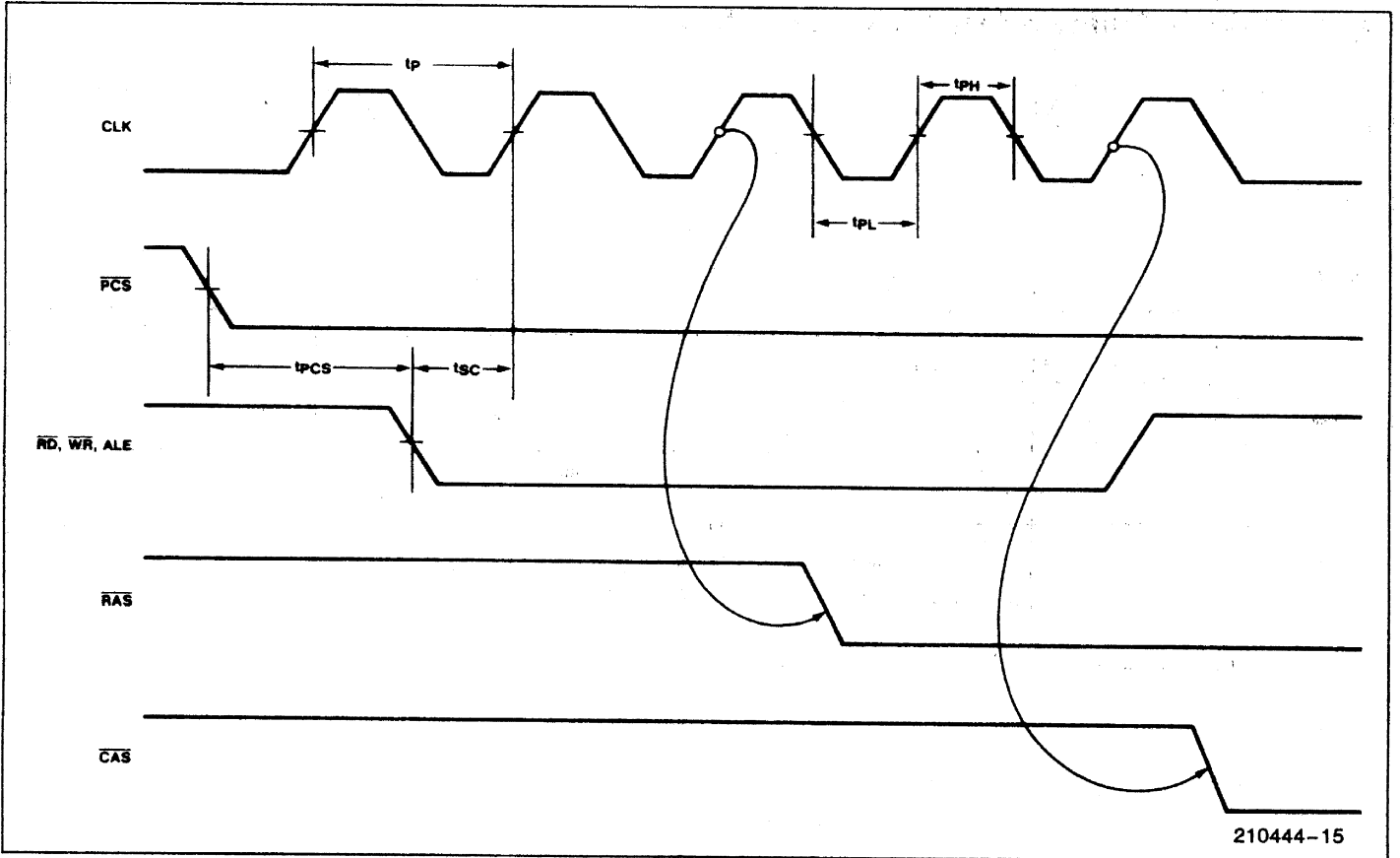
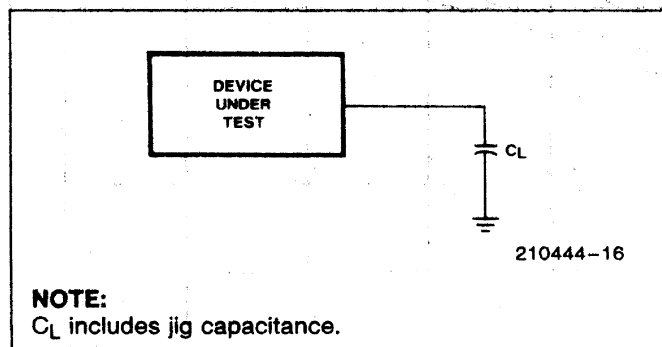

Table 2. 8203 Output Loading. All specifications are for the Test Load unless otherwise noted.

Pin	Test Load
$\overline{SACK}, \overline{XACK}$	$C_L = 30 \text{ pF}$
$\overline{OUT}_0 - \overline{OUT}_6$	$C_L = 160 \text{ pF}$
$\overline{RAS}_0 - \overline{RAS}_3$	$C_L = 60 \text{ pF}$
\overline{WE}	$C_L = 224 \text{ pF}$
\overline{CAS}	$C_L = 320 \text{ pF}$

A.C. TESTING LOAD CIRCUIT



The typical rising and falling characteristic curves for the \overline{OUT} , \overline{RAS} , \overline{CAS} and \overline{WE} output buffers can be used to determine the effects of capacitive loading on the A.C. Timing Parameters. Using this design tool in conjunction with the timing waveforms, the designer can determine typical timing shifts based on system capacitive load.

Example: Find the effect on t_{CR} and t_{CC} using 32 64K Dynamic RAMs configured in 2 banks.

1) Determine the typical \overline{RAS} and \overline{CAS} capacitance:

From the data sheet $\overline{RAS} = 5 \text{ pF}$ and $\overline{CAS} = 5 \text{ pF}$.

$\therefore \overline{RAS} \text{ load} = 80 \text{ pF} + \text{board capacitance.}$

$\overline{CAS} \text{ load} = 160 \text{ pF} + \text{board capacitance.}$

Assume 2 pF/in (trace length) for board capacitance and for this example 4 inches for \overline{RAS} and 8 inches for \overline{CAS} .

2) From the waveform diagrams, we determine that the falling edge timing is needed for t_{CR} and t_{CC} . Next find the curve that *best* approximates the test load; i.e., 68 pF for \overline{RAS} and 330 pF for \overline{CAS} .

3) If we use 88 pF for \overline{RAS} loading, then t_{CR} (min.) spec should be increased by about 1 ns, and t_{CR} (max.) spec should be increased by *about* 2 ns. Similarly if we use 176 pF for \overline{CAS} , then t_{CC} (min.) should decrease by 3 ns and t_{CC} (max.) should decrease by about 7 ns.

A.C. CHARACTERISTICS FOR DIFFERENT CAPACITIVE LOADS

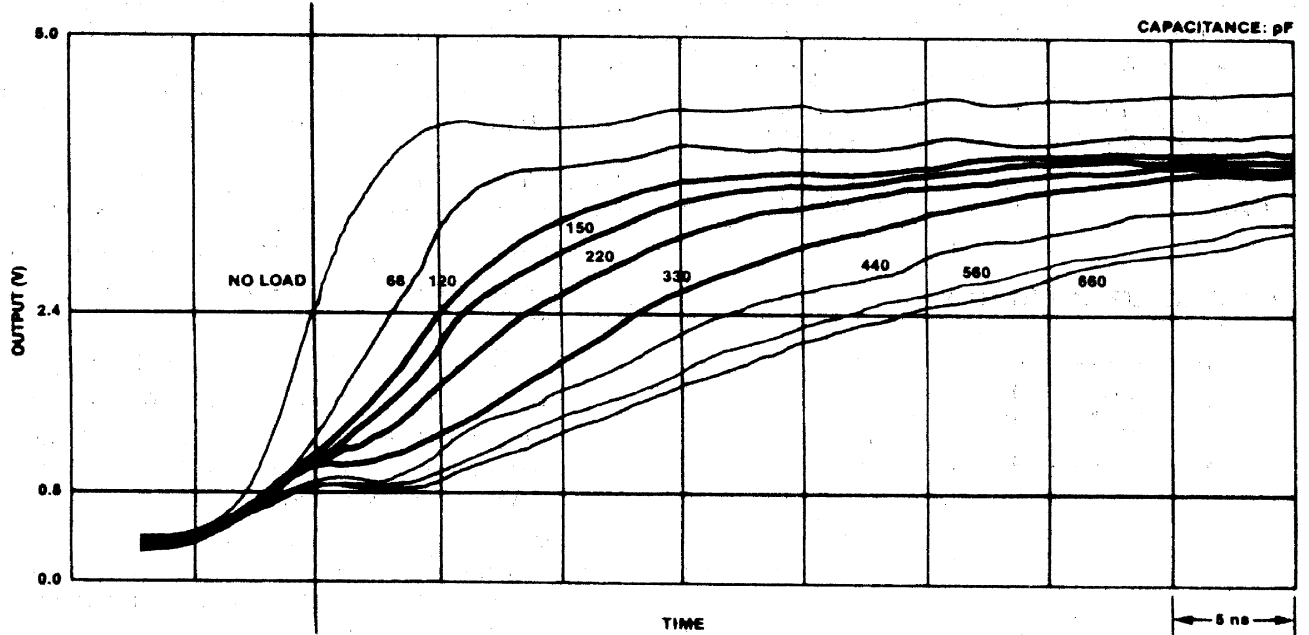

210444-17

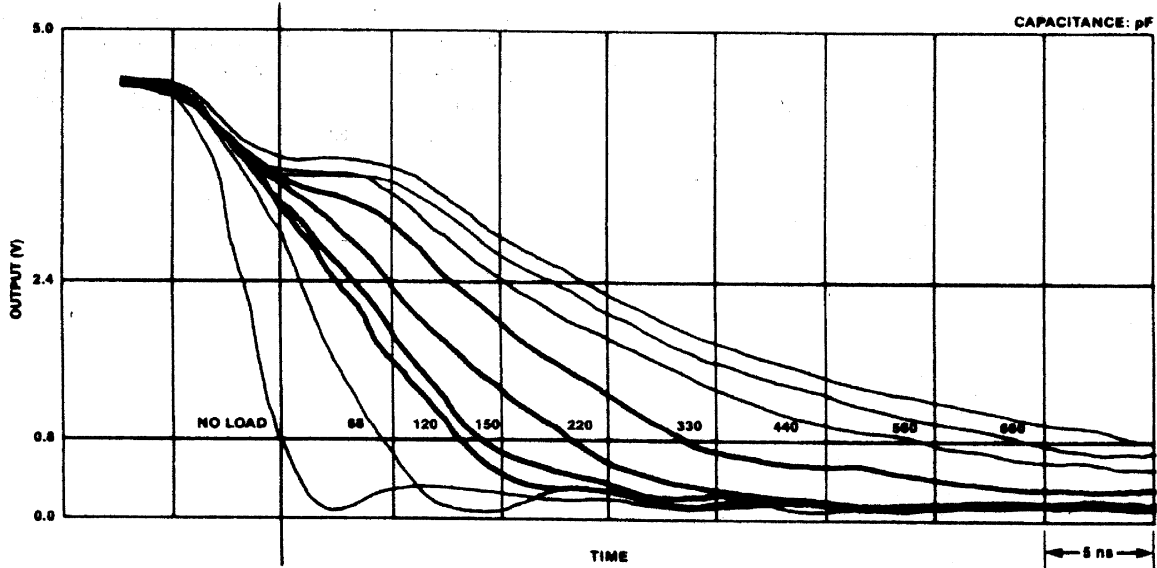

210444-18

NOTE:

Use the Test Load as the base capacitance for estimating timing shifts for system critical timing parameters.

MEASUREMENT CONDITIONS

Pins not measured are loaded with the Test Load capacitance

$T_A = 25^\circ\text{C}$ $V_{CC} = +5\text{V}$ $t_p = 50 \text{ ns}$