

# CD40257B Types

## CMOS Quad 2-Line-to-1-Line Data Selector/Multiplexer

High-Voltage Types (20-Volt Rating)

■ CD40257B is a Data Selector/Multiplexer featuring three-state outputs which can interface directly with and drive data lines of bus-oriented systems. The CD40257B types are supplied in 16-lead hermetic dual-in-line ceramic packages (F3A suffix), 16-lead dual-in-line plastic packages (E suffix), 16-lead small-outline packages (M, M96, MT, and NSR suffixes), and 16-lead thin shrink small-outline packages (PW and PWR suffixes).

**MAXIMUM RATINGS, Absolute-Maximum Values:**

DC SUPPLY-VOLTAGE RANGE, (V <sub>DD</sub> )	
Voltages referenced to V <sub>SS</sub> Terminal	-0.5V to +20V
INPUT VOLTAGE RANGE, ALL INPUTS	-0.5V to V <sub>DD</sub> +0.5V
DC INPUT CURRENT, ANY ONE INPUT	±10mA
POWER DISSIPATION PER PACKAGE (P <sub>D</sub> ):	
For T <sub>A</sub> = -55°C to +100°C	500mW
For T <sub>A</sub> = +100°C to +125°C	Derate Linearly at 12mW/°C to 200mW
DEVICE DISSIPATION PER OUTPUT TRANSISTOR	
FOR T <sub>A</sub> = FULL PACKAGE-TEMPERATURE RANGE (All Package Types)	100mW
OPERATING-TEMPERATURE RANGE (T <sub>A</sub> )	-55°C to +125°C
STORAGE TEMPERATURE RANGE (T <sub>stg</sub> )	-65°C to +150°C
LEAD TEMPERATURE (DURING SOLDERING):	
At distance 1/16 ± 1/32 inch (1.59 ± 0.79mm) from case for 10s max	+265°C

**Features:**

- 3-state outputs
- Standardized, symmetrical output characteristics
- 100% tested for quiescent current at 20 V
- Maximum input current of 1 μA at 18 V over full package-temperature range; 100 nA at 18 V and 25°C
- Noise margin (over full package-temperature range):
  - 1 V at V<sub>DD</sub> = 5 V
  - 2 V at V<sub>DD</sub> = 10 V
  - 2.5 V at V<sub>DD</sub> = 15 V
- 5-V, 10-V, and 15-V parametric ratings
- Meets all requirements of JEDEC Tentative Standard No. 13A, "Standard Specifications for Description of 'B' Series CMOS Devices"

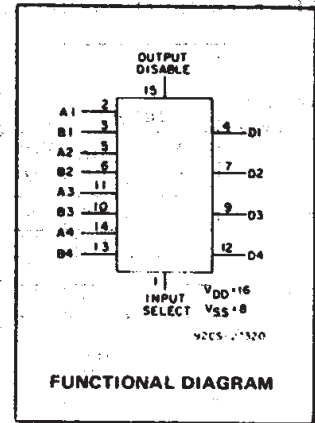

**Applications:**

- Digital Multiplexing
- Shift-right/shift-left registers
- True/complement selection

**RECOMMENDED OPERATING CONDITION**

For maximum reliability, nominal operating conditions should be selected so that operation is always within the following ranges:

CHARACTERISTIC	LIMITS		UNITS
	Min.	Max.	
Supply-Voltage Range (For T <sub>A</sub> =Full Package-Temperature Range)	3	18	V

**TRUTH TABLE**

3-STATE OUTPUT DISABLE	INPUTS		D
	SELECT	A B	
1	X	X X	Z
0	0	0 X	0
0	0	1 X	1
0	1	X 0	0
0	1	X 1	1

X = DON'T CARE LOGIC 1 = HIGH  
LOGIC 0 = LOW Z = HIGH IMPEDANCE

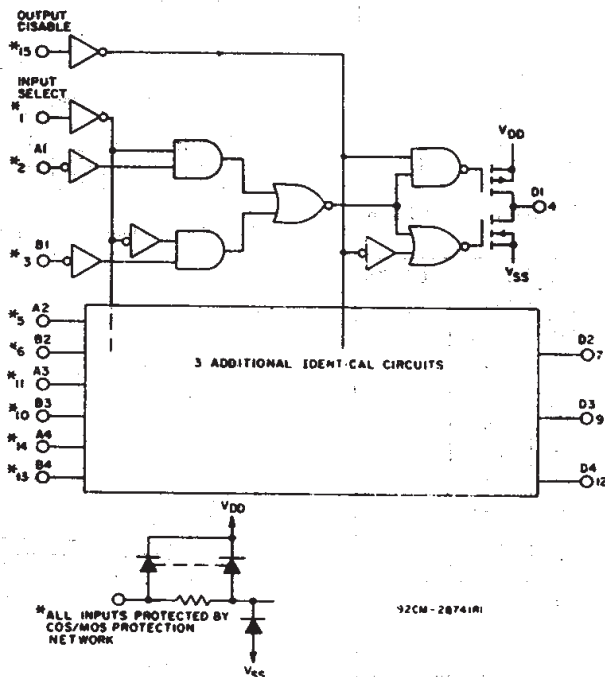

Fig. 1 - Logic diagram for CD40257B.

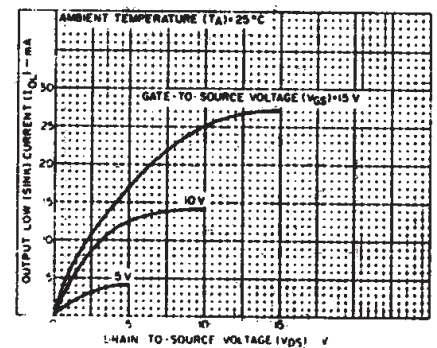

Fig. 2 - Typical output low (sink) current characteristics.

3  
COMMERCIAL CMOS  
HIGH VOLTAGE ICs

# CD40257B Types

## STATIC ELECTRICAL CHARACTERISTICS

CHARACTERISTIC	CONDITIONS			LIMITS AT INDICATED TEMPERATURES (°C)							UNITS
	V <sub>O</sub> (V)	V <sub>IN</sub> (V)	V <sub>DD</sub> (V)	-55	-40	+85	+125	+25			
								Min.	Typ.	Max.	
Quiescent Device Current	-	0.5	5	1	1	30	30	-	0.02	1	μA
I <sub>DD</sub> Max.	-	0.10	10	2	2	60	60	-	0.02	2	
	-	0.15	15	4	4	120	120	-	0.02	4	
Output Low (Sink) Current, I <sub>OL</sub> Min.	0.4	0.5	5	0.64	0.61	0.42	0.36	0.51	1	-	mA
	0.5	0.10	10	1.6	1.5	1.1	0.9	1.3	2.6	-	
	1.5	0.15	15	4.2	4	2.8	2.4	3.4	6.8	-	
Output High (Source) Current, I <sub>OH</sub> Min.	4.6	0.5	5	-0.64	-0.61	-0.42	-0.36	-0.51	-1	-	mA
	2.5	0.5	5	-2	-1.8	-1.3	-1.15	-1.6	-3.2	-	
	9.5	0.10	10	-1.6	-1.5	-1.1	-0.9	-1.3	-2.6	-	
Output Voltage: Low-Level, V <sub>OL</sub> Max.	-	0.5	5			0.05			0	0.05	V
	-	0.10	10			0.05			0	0.05	
	-	0.15	15			0.05			0	0.05	
Output Voltage: High-Level, V <sub>OH</sub> Min.	-	0.5	5			4.95		4.95	5	-	V
	-	0.10	10			9.95		9.95	10	-	
	-	0.15	15			14.95		14.95	15	-	
Input Low Voltage, V <sub>IL</sub> Max.	0.5, 4.5	-	5			1.5		-	-	1.5	V
	1.9	-	10			3		-	-	3	
	1.5, 13.5	-	15			4		-	-	4	
Input High Voltage, V <sub>IH</sub> Min.	0.5, 4.5	-	5			3.5		3.5	-	-	V
	1.9	-	10			7		7	-	-	
	1.5, 13.5	-	15			11		11	-	-	
Input Current, I <sub>IN</sub> Max.	-	0.18	18	±0.1	±0.1	±1	±1	-	±10 <sup>-5</sup>	±0.1	μA
3-State Output Leakage Current I <sub>OUT</sub> Max.		0.18	18	±0.4	±0.4	±12	±12	-	±10 <sup>-4</sup>	±0.4	μA

DYNAMIC ELECTRICAL CHARACTERISTICS at T<sub>A</sub> = 25°C; Input t<sub>r</sub>, t<sub>f</sub> = 20 ns, C<sub>L</sub> = 50 pF, R<sub>L</sub> = 200 KΩ

CHARACTERISTIC	TEST CONDITIONS	LIMITS		UNITS	
		V <sub>DD</sub> (V)	Typ.		Max.
Propagation Delay Time: Data Input to Output, t <sub>PHL</sub> , t <sub>PLH</sub>		5	150	300	ns
		10	70	140	
		15	50	100	
Select to Output, t <sub>PHL</sub> , t <sub>PLH</sub>		5	190	380	ns
		10	85	170	
		15	65	130	
Output Disable to Output, t <sub>PHL</sub> , t <sub>PLH</sub>		5	95	190	ns
		10	50	100	
		15	40	80	
Transition Time, t <sub>THL</sub> , t <sub>TLH</sub>		5	100	200	ns
		10	50	100	
		15	40	80	
Input Capacitance, C <sub>IN</sub>	Any Input	-	5	7.5	pF

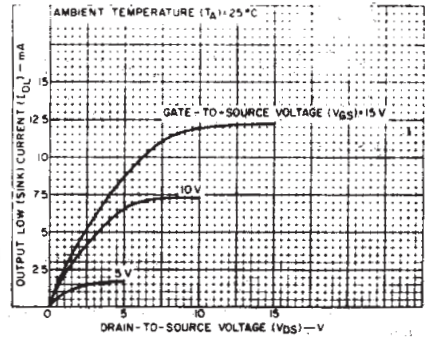

Fig.3 - Minimum output low (sink) current characteristics.

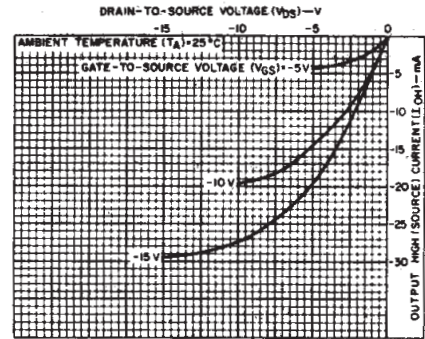

Fig.4 - Typical output high (source) current characteristics.

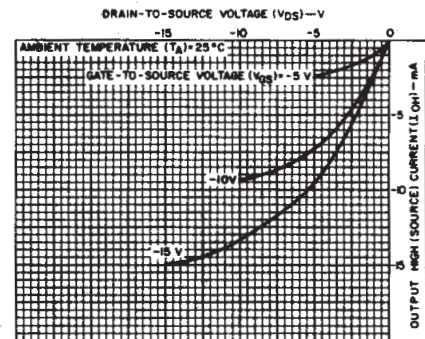

Fig.5 - Minimum output high (source) current characteristics.

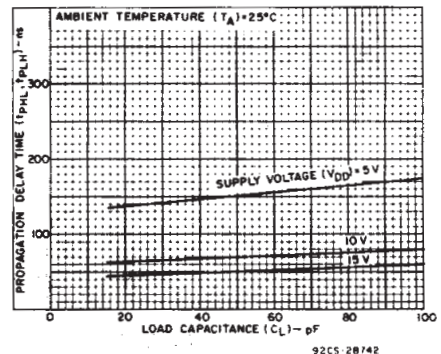

Fig.6 - Typical propagation delay time as a function of load capacitance (DATA INPUT to OUTPUT).

# CD40257B Types

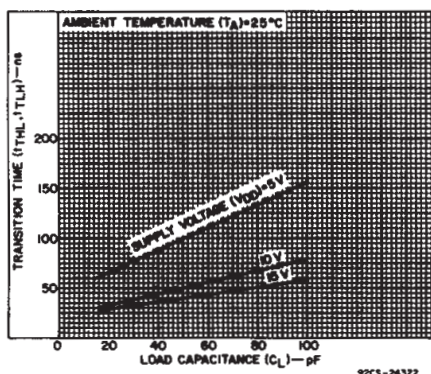

Fig.7 - Typical transition time as a function of load capacitance.

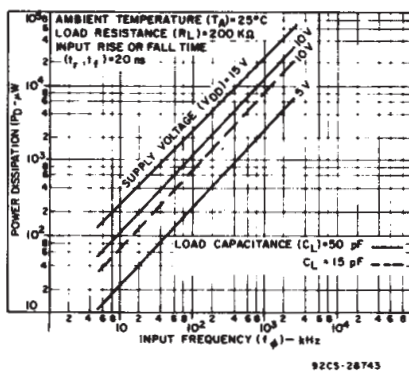

Fig.8 - Typical dynamic power dissipation as a function of input frequency (one INPUT to one OUTPUT).

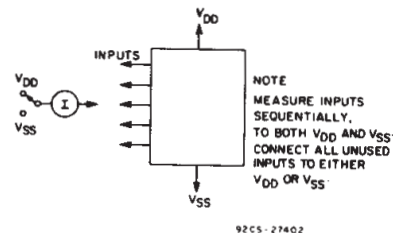

Fig.9 - Input current test circuit.

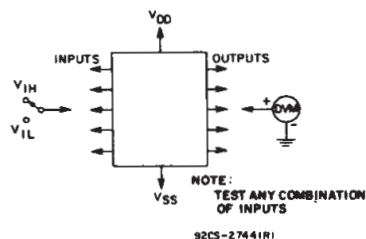

Fig.10 - Input voltage test circuit.

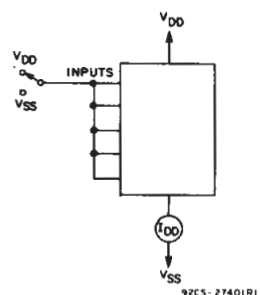
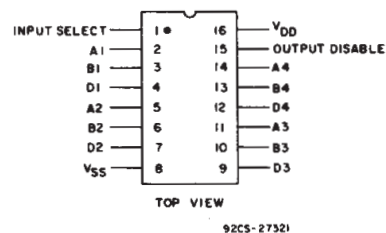
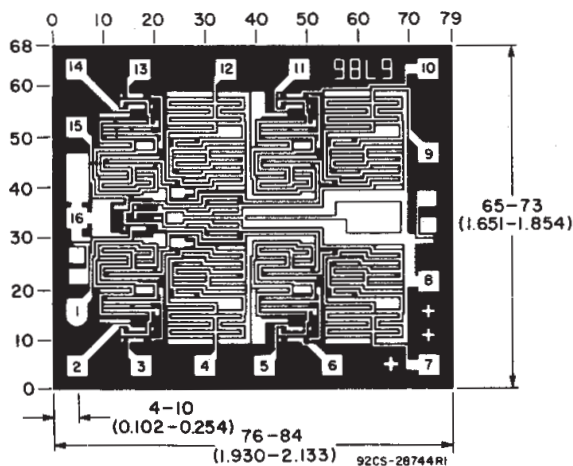

Fig.11 - Quiescent device current test circuit.



TERMINAL ASSIGNMENT

Dimensions and pad layout for CD40257BH.



Dimensions in parentheses are in millimeters and are derived from the basic inch dimensions as indicated. Grid graduations are in mils (10<sup>-3</sup> inch).

3  
COMMERCIAL CMOS  
HIGH VOLTAGE ICs

J (R-GDIP-T\*\*)

14 LEADS SHOWN

CERAMIC DUAL IN-LINE PACKAGE

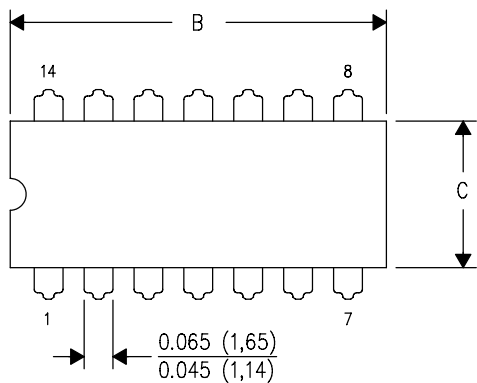

DIM \ PINS **	14	16	18	20
A	0.300 (7,62) BSC	0.300 (7,62) BSC	0.300 (7,62) BSC	0.300 (7,62) BSC
B MAX	0.785 (19,94)	.840 (21,34)	0.960 (24,38)	1.060 (26,92)
B MIN	—	—	—	—
C MAX	0.300 (7,62)	0.300 (7,62)	0.310 (7,87)	0.300 (7,62)
C MIN	0.245 (6,22)	0.245 (6,22)	0.220 (5,59)	0.245 (6,22)

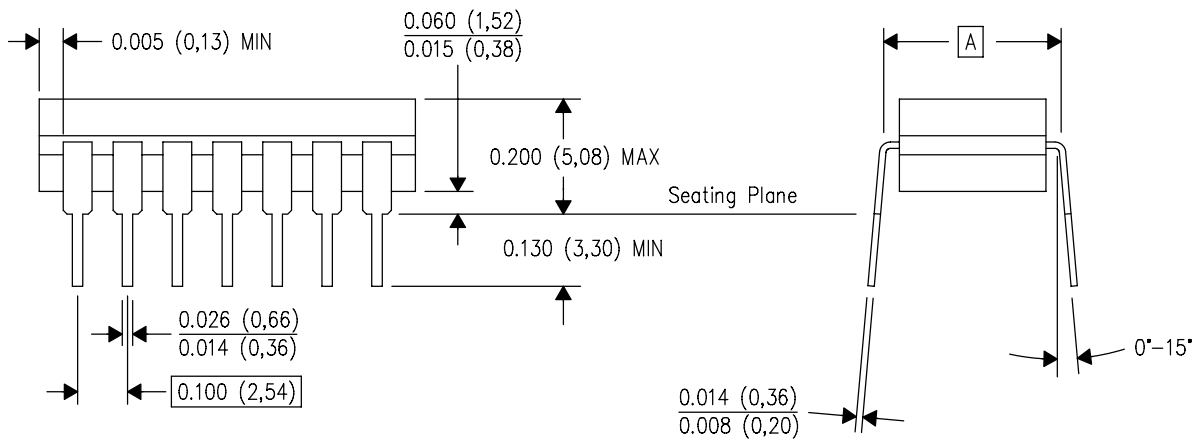

4040083/F 03/03

- NOTES:
- All linear dimensions are in inches (millimeters).
  - This drawing is subject to change without notice.
  - This package is hermetically sealed with a ceramic lid using glass frit.
  - Index point is provided on cap for terminal identification only on press ceramic glass frit seal only.
  - Falls within MIL STD 1835 GDIP1-T14, GDIP1-T16, GDIP1-T18 and GDIP1-T20.

N (R-PDIP-T\*\*)

PLASTIC DUAL-IN-LINE PACKAGE

16 PINS SHOWN

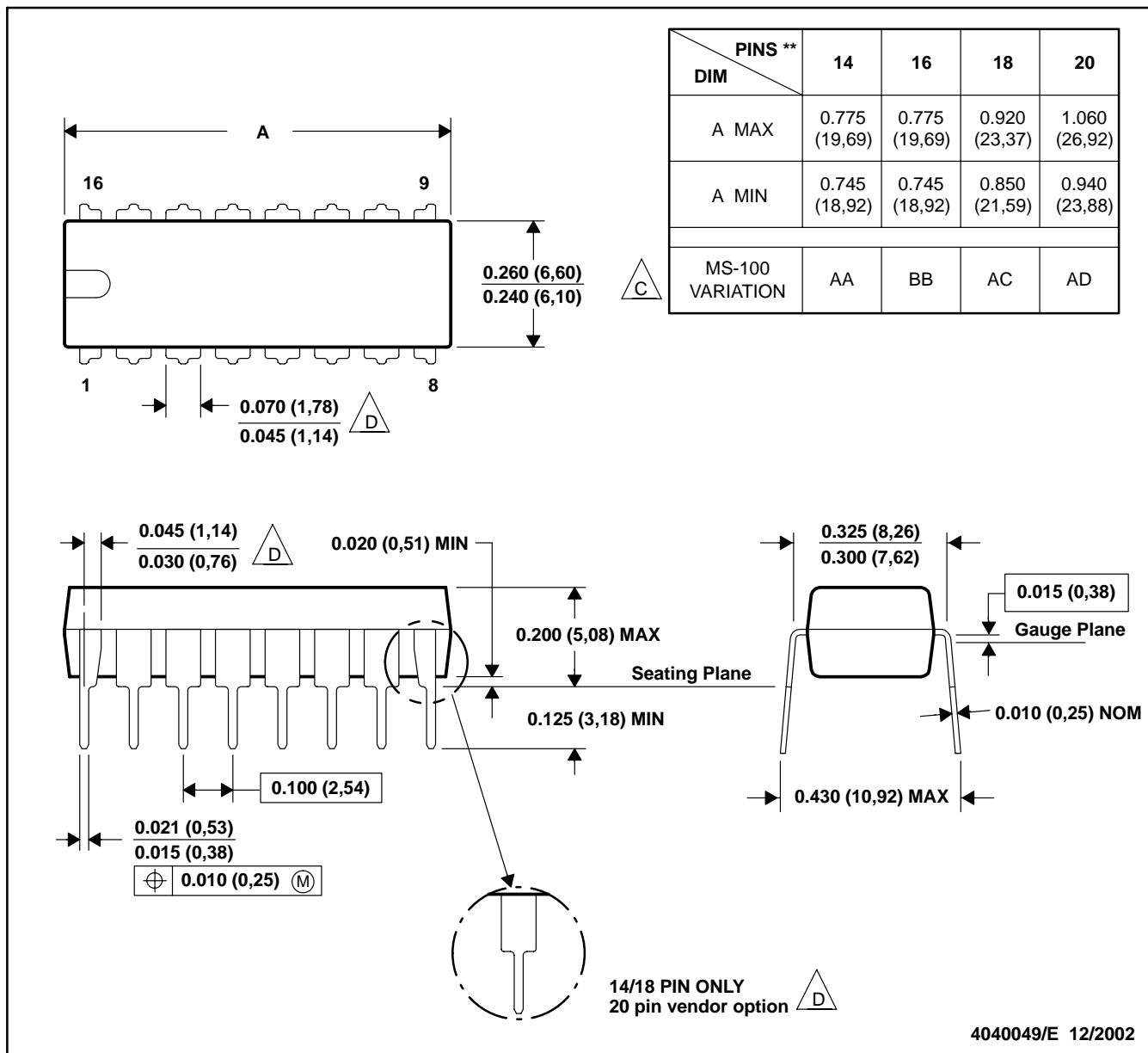

- NOTES: A. All linear dimensions are in inches (millimeters).  
 B. This drawing is subject to change without notice.  
 (C) Falls within JEDEC MS-001, except 18 and 20 pin minimum body length (Dim A).  
 (D) The 20 pin end lead shoulder width is a vendor option, either half or full width.

D (R-PDSO-G\*\*)

PLASTIC SMALL-OUTLINE PACKAGE

8 PINS SHOWN

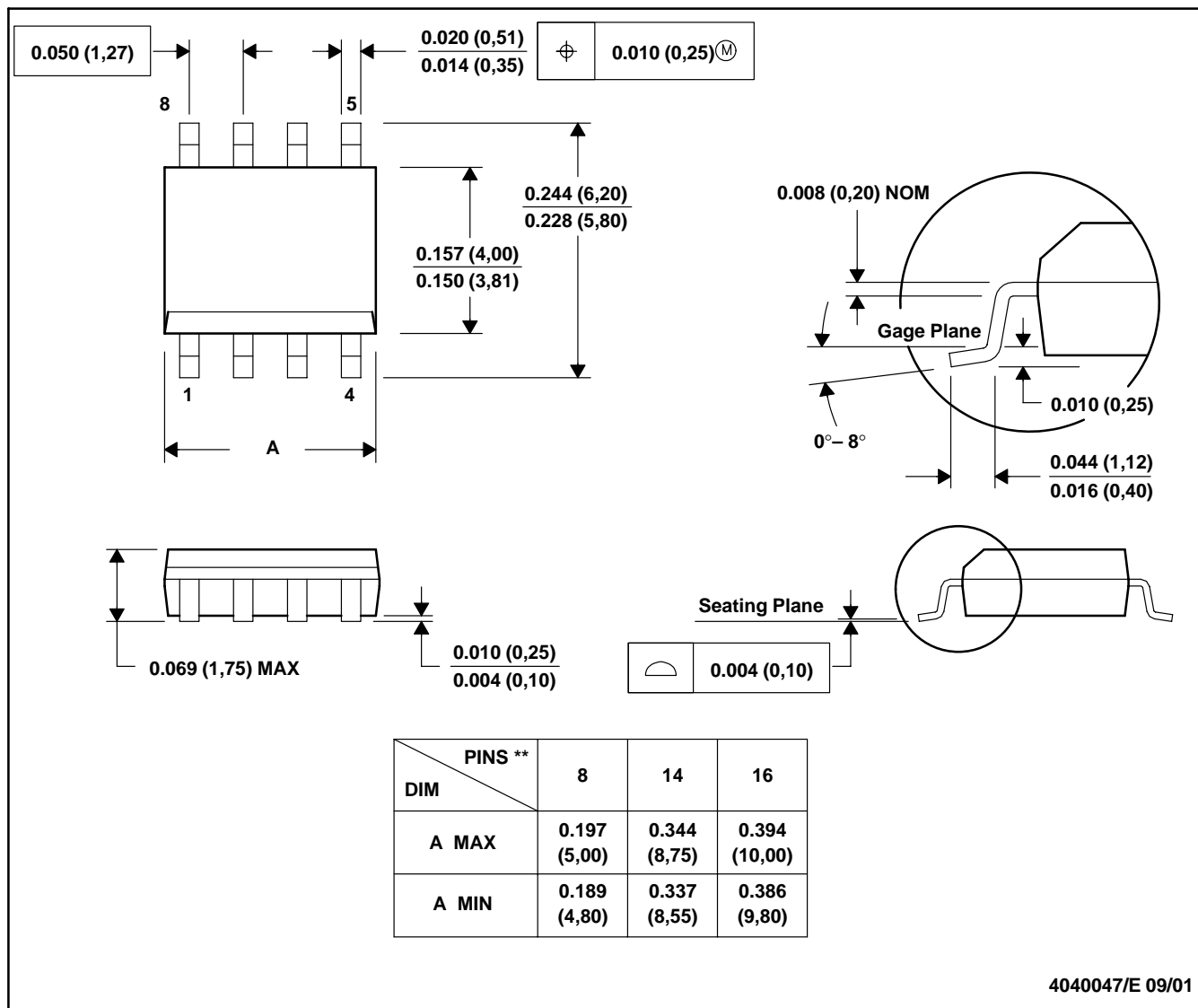

- NOTES: A. All linear dimensions are in inches (millimeters).  
 B. This drawing is subject to change without notice.  
 C. Body dimensions do not include mold flash or protrusion, not to exceed 0.006 (0,15).  
 D. Falls within JEDEC MS-012

# MECHANICAL DATA

NS (R-PDSO-G\*\*)

PLASTIC SMALL-OUTLINE PACKAGE

14-PINS SHOWN

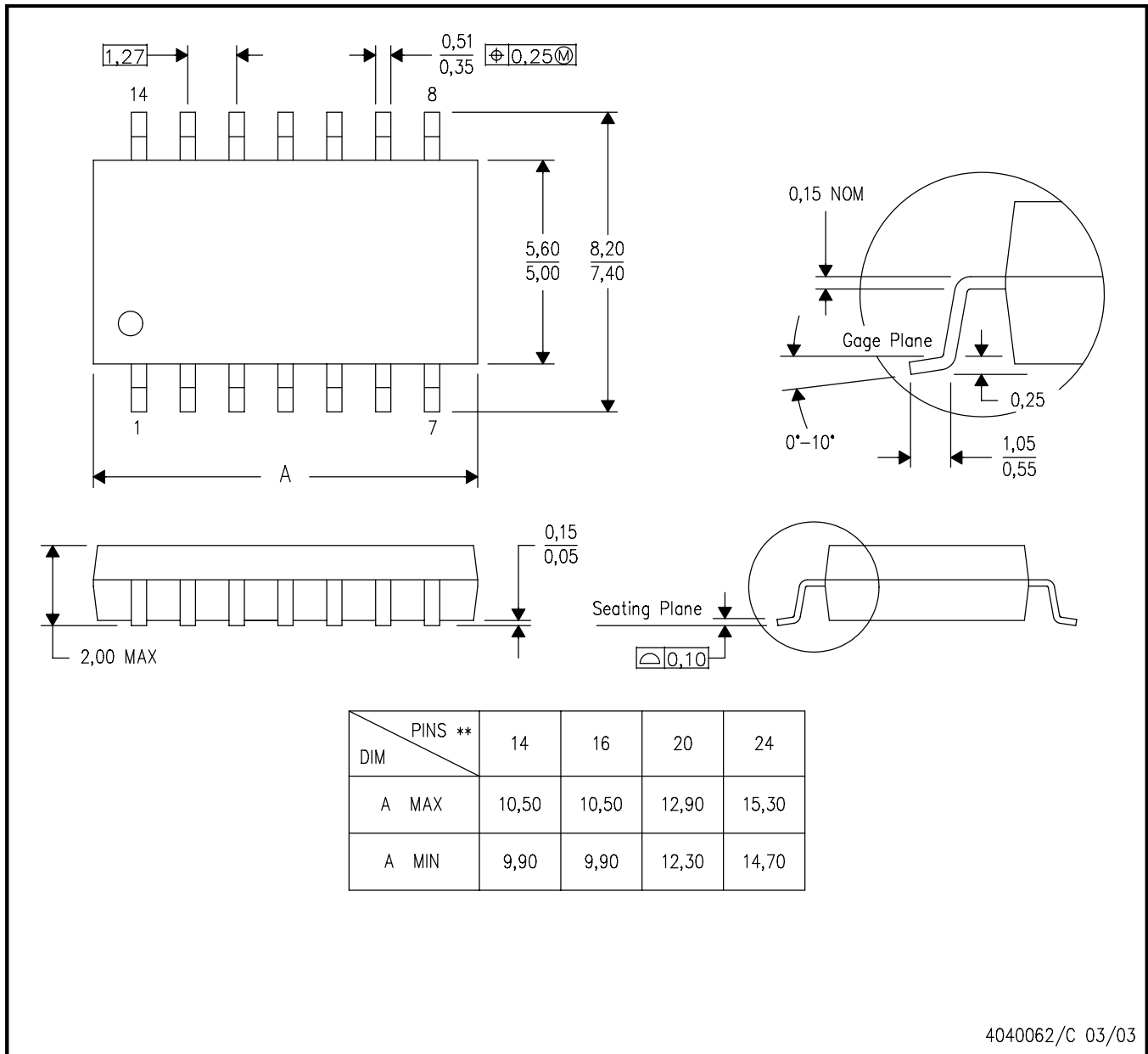

- NOTES:
- A. All linear dimensions are in millimeters.
  - B. This drawing is subject to change without notice.
  - C. Body dimensions do not include mold flash or protrusion, not to exceed 0,15.

PW (R-PDSO-G\*\*)

PLASTIC SMALL-OUTLINE PACKAGE

14 PINS SHOWN

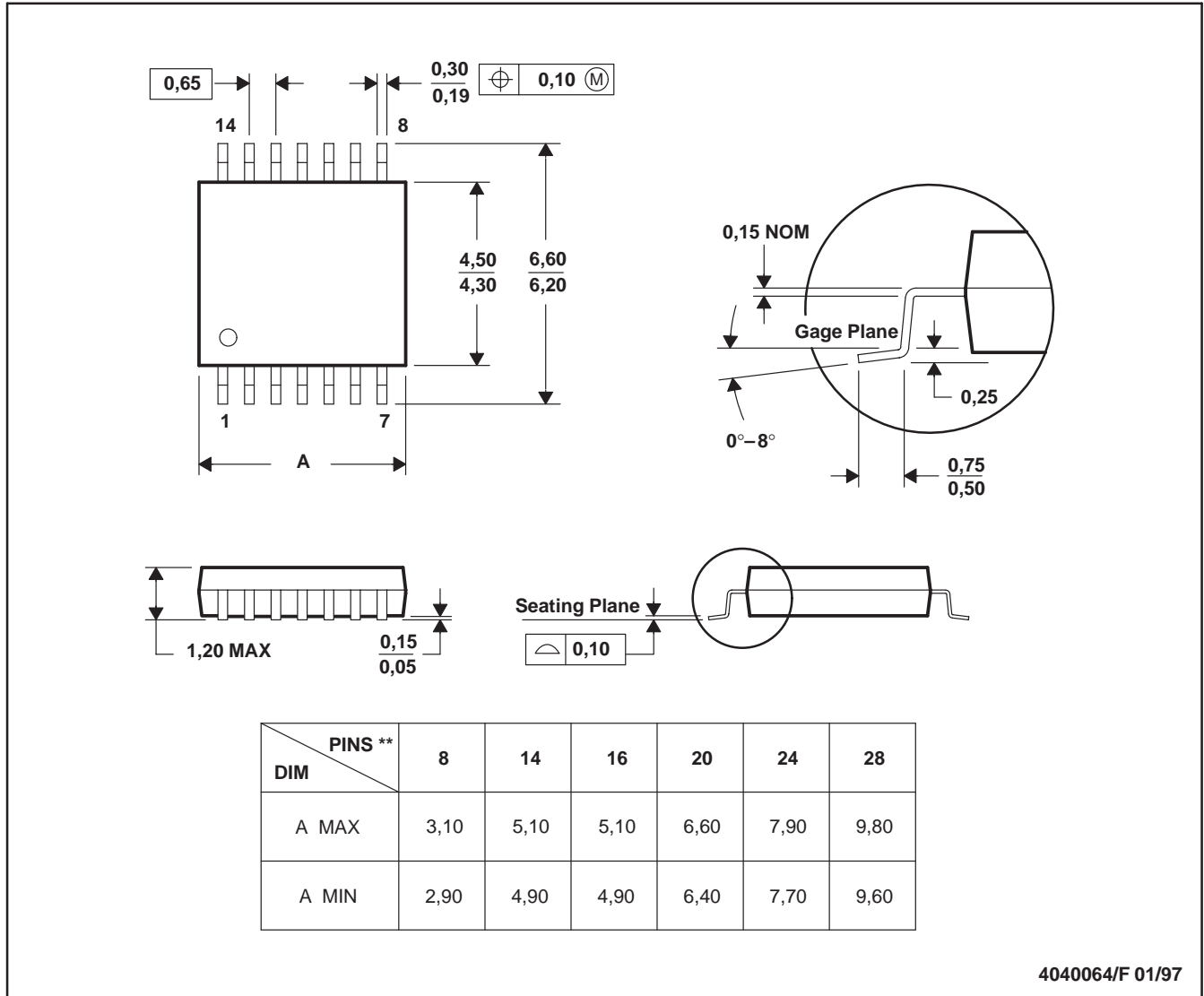

4040064/F 01/97

- NOTES: A. All linear dimensions are in millimeters.  
 B. This drawing is subject to change without notice.  
 C. Body dimensions do not include mold flash or protrusion not to exceed 0,15.  
 D. Falls within JEDEC MO-153

## IMPORTANT NOTICE

Texas Instruments Incorporated and its subsidiaries (TI) reserve the right to make corrections, modifications, enhancements, improvements, and other changes to its products and services at any time and to discontinue any product or service without notice. Customers should obtain the latest relevant information before placing orders and should verify that such information is current and complete. All products are sold subject to TI's terms and conditions of sale supplied at the time of order acknowledgment.

TI warrants performance of its hardware products to the specifications applicable at the time of sale in accordance with TI's standard warranty. Testing and other quality control techniques are used to the extent TI deems necessary to support this warranty. Except where mandated by government requirements, testing of all parameters of each product is not necessarily performed.

TI assumes no liability for applications assistance or customer product design. Customers are responsible for their products and applications using TI components. To minimize the risks associated with customer products and applications, customers should provide adequate design and operating safeguards.

TI does not warrant or represent that any license, either express or implied, is granted under any TI patent right, copyright, mask work right, or other TI intellectual property right relating to any combination, machine, or process in which TI products or services are used. Information published by TI regarding third-party products or services does not constitute a license from TI to use such products or services or a warranty or endorsement thereof. Use of such information may require a license from a third party under the patents or other intellectual property of the third party, or a license from TI under the patents or other intellectual property of TI.

Reproduction of information in TI data books or data sheets is permissible only if reproduction is without alteration and is accompanied by all associated warranties, conditions, limitations, and notices. Reproduction of this information with alteration is an unfair and deceptive business practice. TI is not responsible or liable for such altered documentation.

Resale of TI products or services with statements different from or beyond the parameters stated by TI for that product or service voids all express and any implied warranties for the associated TI product or service and is an unfair and deceptive business practice. TI is not responsible or liable for any such statements.

Following are URLs where you can obtain information on other Texas Instruments products and application solutions:

<b>Products</b>		<b>Applications</b>	
Amplifiers	<a href="http://amplifier.ti.com">amplifier.ti.com</a>	Audio	<a href="http://www.ti.com/audio">www.ti.com/audio</a>
Data Converters	<a href="http://dataconverter.ti.com">dataconverter.ti.com</a>	Automotive	<a href="http://www.ti.com/automotive">www.ti.com/automotive</a>
DSP	<a href="http://dsp.ti.com">dsp.ti.com</a>	Broadband	<a href="http://www.ti.com/broadband">www.ti.com/broadband</a>
Interface	<a href="http://interface.ti.com">interface.ti.com</a>	Digital Control	<a href="http://www.ti.com/digitalcontrol">www.ti.com/digitalcontrol</a>
Logic	<a href="http://logic.ti.com">logic.ti.com</a>	Military	<a href="http://www.ti.com/military">www.ti.com/military</a>
Power Mgmt	<a href="http://power.ti.com">power.ti.com</a>	Optical Networking	<a href="http://www.ti.com/opticalnetwork">www.ti.com/opticalnetwork</a>
Microcontrollers	<a href="http://microcontroller.ti.com">microcontroller.ti.com</a>	Security	<a href="http://www.ti.com/security">www.ti.com/security</a>
		Telephony	<a href="http://www.ti.com/telephony">www.ti.com/telephony</a>
		Video & Imaging	<a href="http://www.ti.com/video">www.ti.com/video</a>
		Wireless	<a href="http://www.ti.com/wireless">www.ti.com/wireless</a>

Mailing Address: Texas Instruments  
Post Office Box 655303 Dallas, Texas 75265

Copyright © 2003, Texas Instruments Incorporated