

**BBK - S4**

**ADAPTER FOR SBUS SYSTEMS.**

CWA  
Computergesellschaft für  
wissenschaftliche Anwendungen m.b.H.  
D-5100 Aachen, Mozartstr. 2a

---

## Table of Contents

<b>1. Functional description .....</b>	<b>3</b>
<b>2. Installation .....</b>	<b>4</b>
<b>3. Jumper configuration .....</b>	<b>8</b>
3.1 Link Configuration.....	9
3.2 Link Speed Settings : Jumpers J2 to J4.....	10
3.3 Link Standard Configuration.....	12
3.3.1 Parsytec Standard .....	13
3.3.2 Inmos Standard .....	15
3.4 Jumper Default Settings.....	17
<b>4. Memory configuration.....</b>	<b>18</b>
4.1 The Dual Ported Ram .....	21
4.2 The Standard BBK-S4 Protocol.....	23
4.3 Programming a BBK-S4 Link Protocol.....	25
<b>5. Pin layout for the DIN connector and the link connectors .....</b>	<b>26</b>
<b>6. Technical Data.....</b>	<b>30</b>

## 1. Functional description

The **BBK-S4** Adapter was built as interface between SBUS-Systems (such as SUN Workstations or compatible **SBUS**-Stations) and transputer systems or transputer networks. The **BBK-S4** Adapter itself uses the Inmos Transputer **IMS-T222** as main processing unit. The **T222** links service a fast and powerful linkage between up to four transputer systems (transputer networks) and a **SBUS**-server. The **BBK-S4** Adapter multiplexes the four bi-directional serial data streams of the links L0 to L3 into a parallel data stream that is processed by the **SBUS**.

The serial communication of connected transputer networks with the **SBUS**-server is executed by an integrated link interface using standard link protocol. The communication speed of links L0 to L3 can be set from 5 Mbit/s up to 20 Mbit/s (see Jumper settings in Chapter 3 of this manual; Default setting is 20 Mbit/s for every link)

The figure below shows the principal logic outline of the **BBK-S4** Adapter. The T222 Transputer services all needed and desired functions for proper communication of **SBUS**-server and transputer networks. Since most functions are implemented as software the **BBK-S4** Adapter is also very tolerant towards customized communication needs (see Chapter 4 to customized protocol software).

This flexibility is achieved by the use of two custom EPROMs the Firmware EPROM and the Config EPROM. The Firmware EPROM holds bootable code and the protocol description. The Config EPROM is needed because all **SBUS** boards must identify themselves. (see **SBUS** description)

The backplane of the adapter board holds four high precision 6-pin plugs for the connection of twisted pair link cables (LEMOSA-Standard). The maximum distance for link communication at 20 Mbit/s is 10 meters. However, it is recommended to use link cables as short as possible in order to avoid or minimize possible data damage.

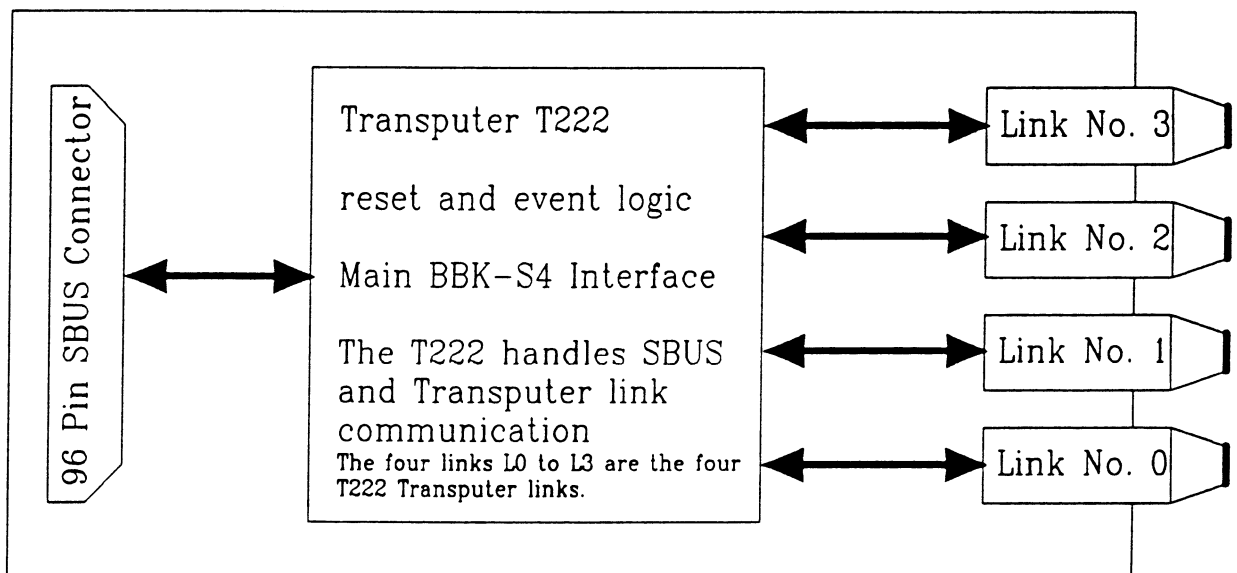

Fig. 1.1

Logic outline of **BBK-S4** Adapter design. (Top View)

## 2. Installation

Read this section carefully before you start installing the **BBK-S4** Adapter board in your **SBUS** system !

Chances are that any questions you might have will be answered in this booklet. Also it prevents you from damaging your system or the **BBK-S4** Adapter board.

Static Precaution : Static electricity can damage electronic circuitry on microchips and printed circuit boards. Since even ordinary amounts on static electricity from clothes or work environment can damage them you should handle boards only by their non conducting edges. Avoid touching any components or metal parts. We recommend to wear a grounding strap when handling the boards.

Also do not disconnect the systems power cord since this connection provides grounding. However, make sure the system is switched **OFF** by observing that **NO LED** (light-emmiting diode) is lit.

When installing the board write down the slot number where you inserted the board. The slot number is needed during software installation so write it down careful to avoid complicated reinstallation.

Further information on how to find an empty **SBUS**-Slot and how to install **SBUS**-Boards is given in your System Manual in a chapter possibly called *Installing SBUS-Boards*.

## 2.1 Installing the **BBK-S4** adapter in a **SBUS**-workstation

To install the adapter in the workstation to be used as transputer host system follow the few steps listed below.

### First time system installation :

If a new system (powered off) should be equipped with the **BBK-S4** Adapter install the board before powering the system.

### Installation in an already running system :

Since **SBUS** Systems are **UNIX**<sup>1</sup> Systems they must be **SHUTDOWN** before turning **OFF** the power switch. How to shutdown your system and how to store all data is described in the *User's Guide* of your *System Manual*.

If now your system is turned **OFF** you can remove the system unit cover and select a free **SBUS**-Slot.

Take cautions about static electricity (see above) !

Now connect the 96-pin DIN connector with the desired slot. Be careful when inserting the board, due to the smallness of the connector pins insert the board very carefully to avoid connector damage.

Make sure all pins are at their correct place and not damaged !

This connector design implies that you remove or re-insert the board as seldom as possible. All Jumper settings can be changed without removing the board.

Write down the Slot No. since this number is needed during the software installation.

All other information as Slot Offset, Interrupt line No. e.t.c. is provided in your *System Manual* !

Now you can begin to re-assemble your system and start software installation.

---

<sup>1</sup> Unix is a registered trademark of AT&T Bell Laboratories

---

For software installation you must connect at least one link with a transputer system. This linkage must conform in link speed, and link standard with the **BBK-S4** Adapter settings for this link !

Caution : Before closing up your system and starting software installation check **ALL** Jumpers for correct settings. Do **NOT** rely on correct default settings. Shipment might have caused pins to fall out.

## 2.2 Software Installation

With the **BBK-S4** adapter board you receive driver software that allows you to start working with the **BBK-S4** adapter. Installing the software takes two steps :

1. Installation of *Basic Transputer System Software for SUN 3/4*
2. Installation on transputer development software as *Helios, Toolkit...* .

For the complete software installation procedure refer to the *Basic Transputer System Software for SUN 3/4 Manual*.

Note : For complete software installation and first board checkup, connect at least one link of the **BBK-S4** Adapter with a Transputer system. Same link speed and link standard on transputer side as on **BBK-S4** Adapter is necessary. (Use standard link cable only !)

### 3. Jumper configuration

The **BBK-S4** Adapter board has several jumpers for proper configuration. There are two sets of jumpers and one set of resistor plugs :

The first set, jumpers J1 to J4, is used to configure the board and to select the desired link speed for links L0 to L3 separately. The possible communication speed ranges from 5 Mbit/s up to 20 Mbit/s. The default setting is 20 Mbit/s for every link.

Jumpers J5 to J12 form the second set of jumpers which select the proper link communication standard. Parsytec and Inmos Standard is available. Default Standard is Parsytec Standard.

Finally you have four resistor sockets RP3, RP4, RP7 and RP8 these sockets are also used to configure the proper link standard.

The sockets accept standard 8-pin SIL's with a resistance off 4x220 Ohm, i.e you can insert the sockets without regarding polarity.

The Link Standard selection always uses both, the jumpers J5 to J8 and the four resistor sockets.

The figure below shows the jumper location on the board. Note that the jumper positions are relative to their actual location.

All jumpers are located on Component Layer

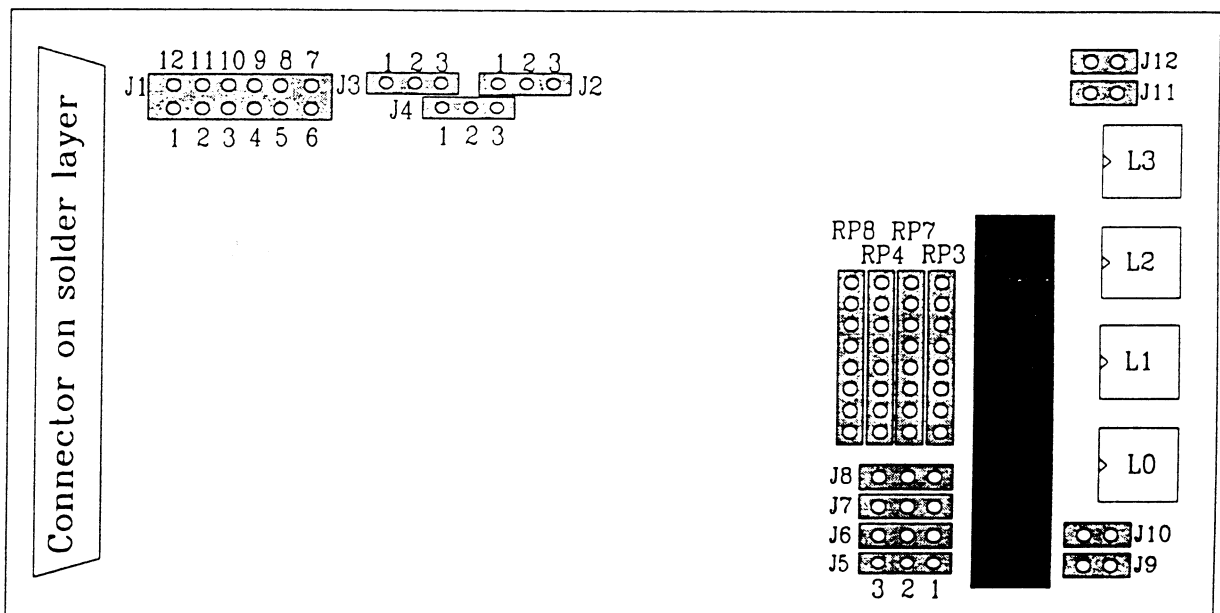

Fig. 3.1

Jumper location on **BBK-S4** Adapter



### 3.1 Link Configuration

Jumper J1 is used to select the proper interrupt line for the adapter board in your spare SUN-slot. With the selection of one Interrupt line the SBUS Slot Offset is selected. Information on Slot Offset can be gathered in your station's *System Manual*.

The default setting (Set J1: 2-1) is needed by the *Basic Transputer System Software for SUN 3/4* and other development tools (like MultiTool...).

The connection of plugs J1: 7-8 is reserved for future use. Do not connect these pins !

Jumper Setting for Jumper J1		
Plugs	Function	
	1-12	No Operation
	2-11	Selects Non Interrupt Mode (Default)
	1- 2	Sets SBUS Interrupt request on line 4 (IntReq(4), low active)
	2- 3	Sets SBUS Interrupt request on line 5
	4- 5	Sets SBUS Interrupt request on line 6
	5- 6	Sets SBUS Interrupt request on line 7
	7- 8	Not connected (Reserved setting)
	8- 9	Sets SBUS Interrupt request on line 3
	10-11	Sets SBUS Interrupt request on line 2
	11-12	Sets SBUS Interrupt request on line 1

Fig 3.1.1 Jumper Settings For Configuration Jumper J1

### 3.2 Link Speed Settings : Jumpers J2 to J4

The Link Speed Jumpers J2 to J4 are located on the **BBK-S4** Adapter board as shown below

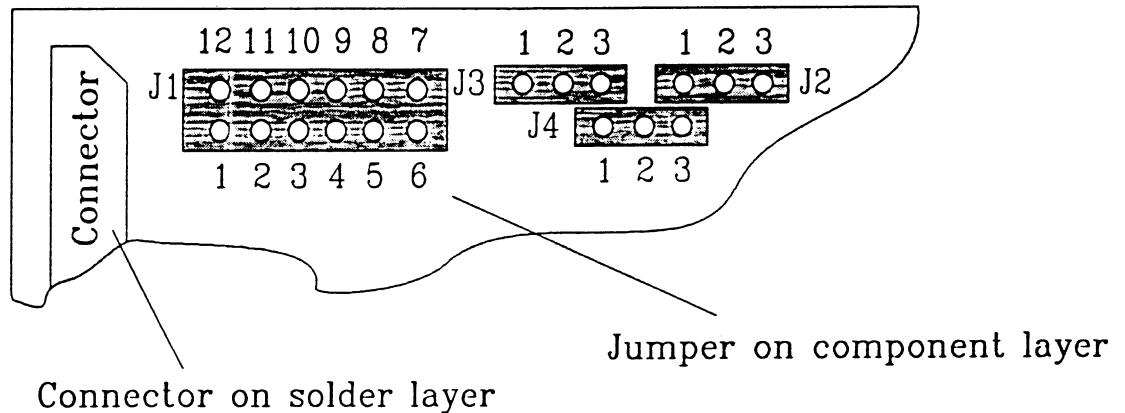

Fig 3.2.1 Link Speed Jumpers J2 to J4 on **BBK-S4** Adapter

**Note:** Do **NEVER** cross-connect any of the Jumpers. A cross-connection will short-circuit undefined settings and definitely destroy the board.

Jumpers J2, J3 and J4 are used to select the desired link speed for links L0 and links L1 to L3. The tables on next page hold all possible settings for jumpers J2, J3 and J4. also it shows that the Jumper settings J3 and J4 depend on the two possible settings for jumper J2. The default link speed for all links is 20 Mbit/s.

**Note :** Jumper settings are **never** to be changed while the adapter board is working !  
Always **SHUTDOWN** your system first and then switch power off. Now you should be able to rearrange the jumpers easily without removing the board from its slot. If, however, it is necessary to remove the board do this very carefully in order not to damage the **SBUS** Connector pins.

Always take caution about static electricity (see above).

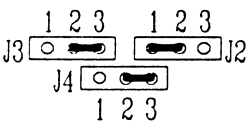
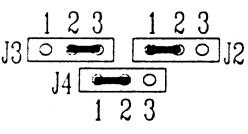
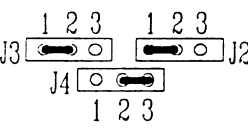
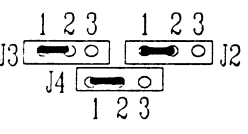
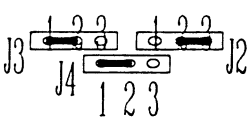
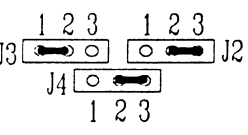
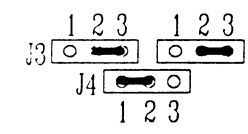
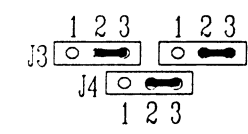
Link L0	Links L1-L3	Possible Jumper Settings
5 Mbit/s	5 Mbit/s	 <p>Set J2: 2-1 Set J3: 2-3 Set J4: 2-3</p>
5 Mbit/s	10 Mbit/s	 <p>Set J2: 2-1 Set J3: 2-3 Set J4: 2-1</p>
10 Mbit/s	5 Mbit/s	 <p>Set J2: 2-1 Set J3: 2-1 Set J4: 2-3</p>
10 Mbit/s	10 Mbit/s	  <p>Set J2: 2-1 Set J3: 2-1 Set J4: 2-1 or Set J2: 2-3 Set J3: 2-1 Set J4: 2-1</p>
10 Mbit/s	20 Mbit/s	 <p>Set J2: 2-3 Set J3: 2-1 Set J4: 2-3</p>
20 Mbit/s	10 Mbit/s	 <p>Set J2: 2-3 Set J3: 2-3 Set J4: 2-1</p>
20 Mbit/s	20 Mbit/s	 <p>Set J2: 2-3 Set J3: 2-3 Set J4: 2-3</p>

Tab. 3.2.1 Table for all possible link speed configurations.

### 3.3 Link Standard Configuration

For maximum compatibility the **BBK-S4** Adapter can switch between two Link Standards, the Parsytec Standard and the Inmos Standard. To easily change between these standards some additional jumpers (J5 to J10) and resistor sockets RP3, RP4, RP7 and RP8 were added.

In order to maximize variability you can change link standards separately. Links L0/L1 and links L2/L3 can be configured, i.e. you can operate the board with Parsytec Standard applying to links L0 and L1 and the two other links, L2/L3 follow the Inmos Standard.

Parsytec Link Standard is default !

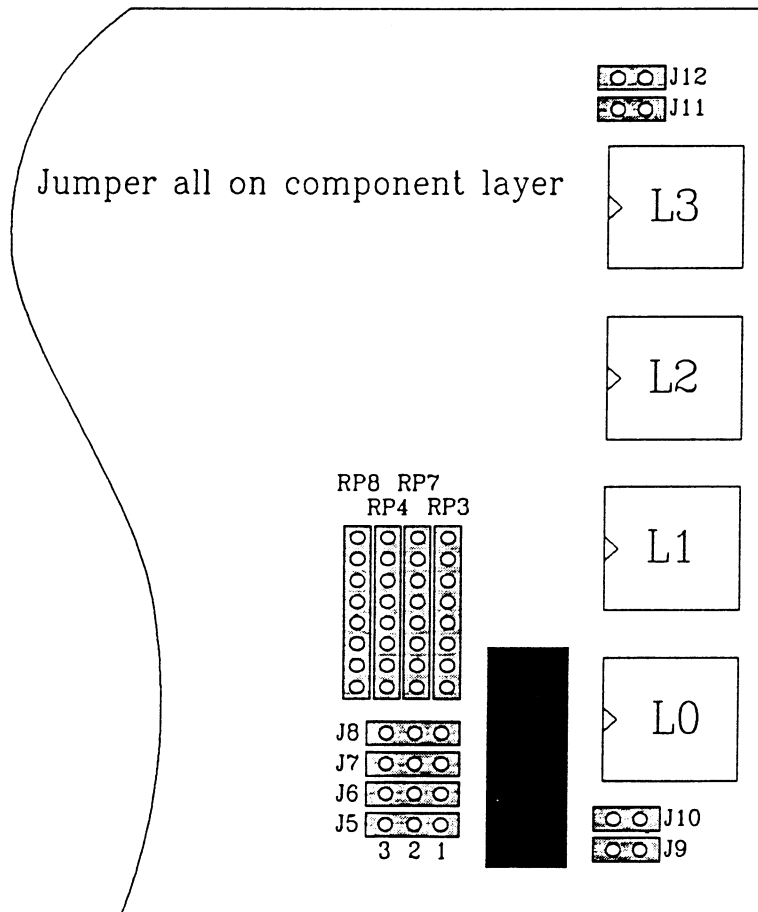

Fig. 3.3.1. Location for Jumpers J5 to J12 and Resistor Sockets RP3 to RP8

**Note:** Do **NEVER** cross-connect any of the Jumpers. A cross-connection will short-circuit undefined settings and definitely destroy the board.

### 3.3.1 Parsytec Standard

The following two pages describe the jumper and resistor settings in case of Parsytec Standard.

Jumpers J9/J10 and/or Jumpers J11/J12 **must always be set** when using this mode

#### Links L0 and L1

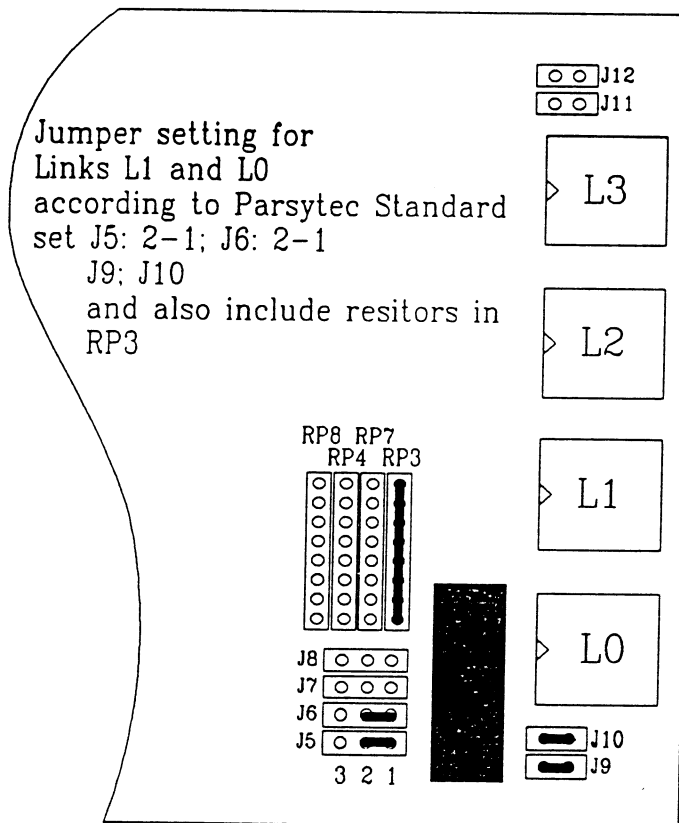

Fig 3.3.1.1 Parsytec Link Standard for Links L0 and L1

**Note :**

Jumper settings are **never** to be changed while the adapter board is working !

Always **SHUTDOWN** your system first and then switch power off. Now you should be able to rearrange the jumpers easily without removing the board from its slot. If, however, it is necessary to remove the board do this very carefully in order not to damage the **SBUS** Connector pins.

Always take caution about static electricity (see above).

Parsytec Standard

Jumper settings for jumpers J5 to J12

Links L2 and L3

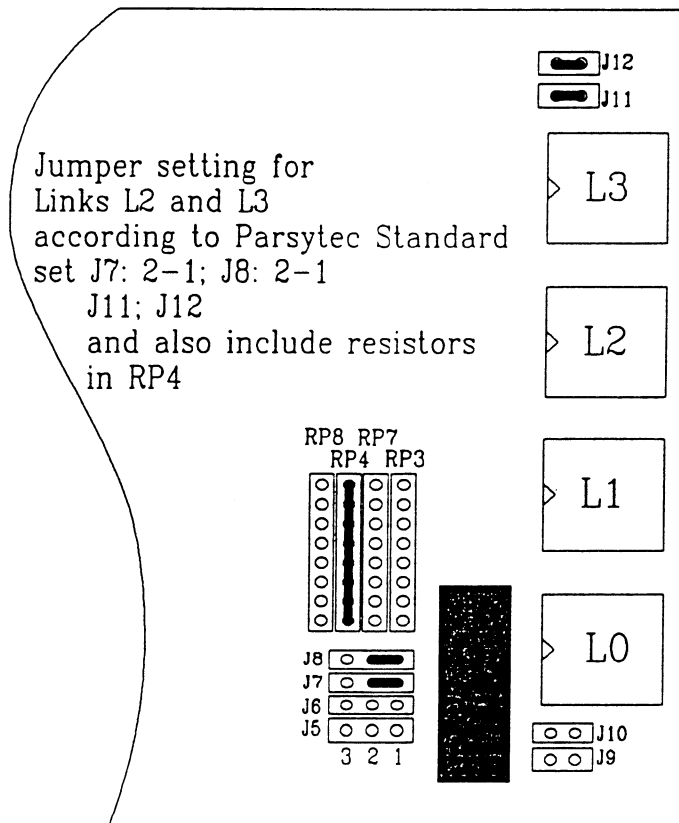

Fig 3.3.1.2 Parsytec Link Standard for Links L2 and L3

Note :

Jumper settings are **never** to be changed while the adapter board is working !

Always **SHUTDOWN** your system first and then switch power off. Now you should be able to rearrange the jumpers easily without removing the board from its slot. If, however, it is necessary to remove the board do this very carefully in order not to damage the **SBUS** Connector pins.

Always take caution about static electricity (see above).

### 3.3.2 Inmos Standard

Following are the jumper and resistor settings applying to the Inmos Link Standard.

#### Links L0 and L1

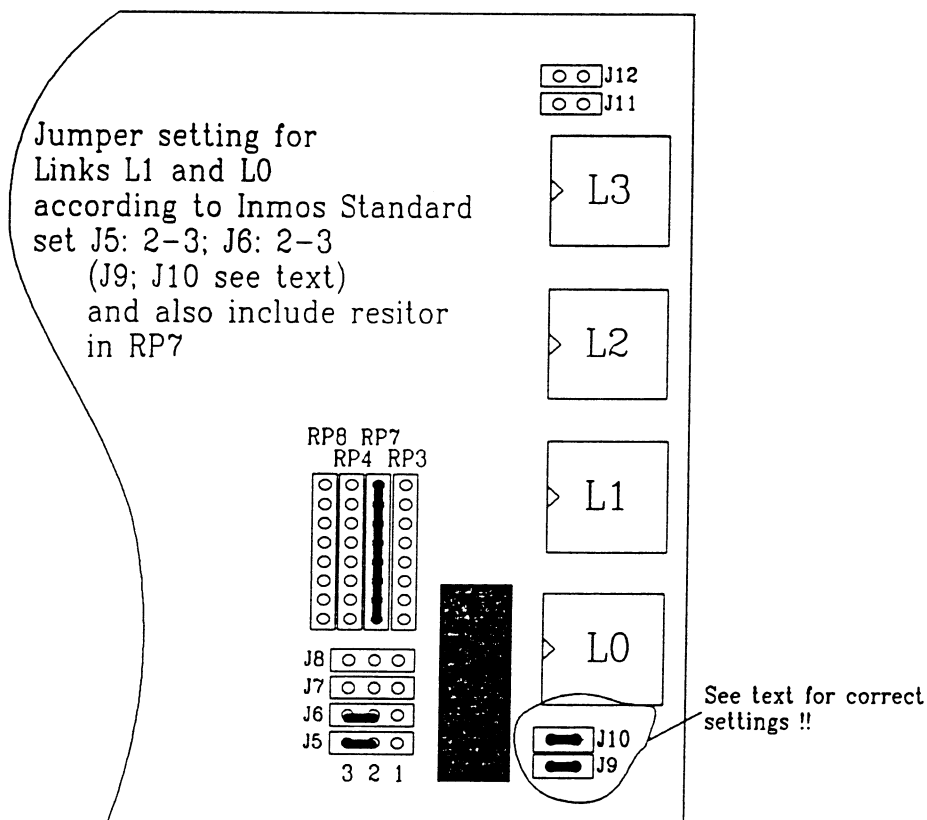

Fig 3.3.2.1 Inmos Link Standard for Links L0 and L1

**Note :** Jumper settings are **never** to be changed while the adapter board is working !  
 Always **SHUTDOWN** your system first and then switch power off. Now you should be able to rearrange the jumpers easily without removing the board from its slot. If, however, it is necessary to remove the board do this very carefully in order not to damage the **SBUS** Connector pins.

Always take caution about static electricity (see above).

Inmos Standard

Jumper settings for jumpers J5 to J12

Links L2 and L3

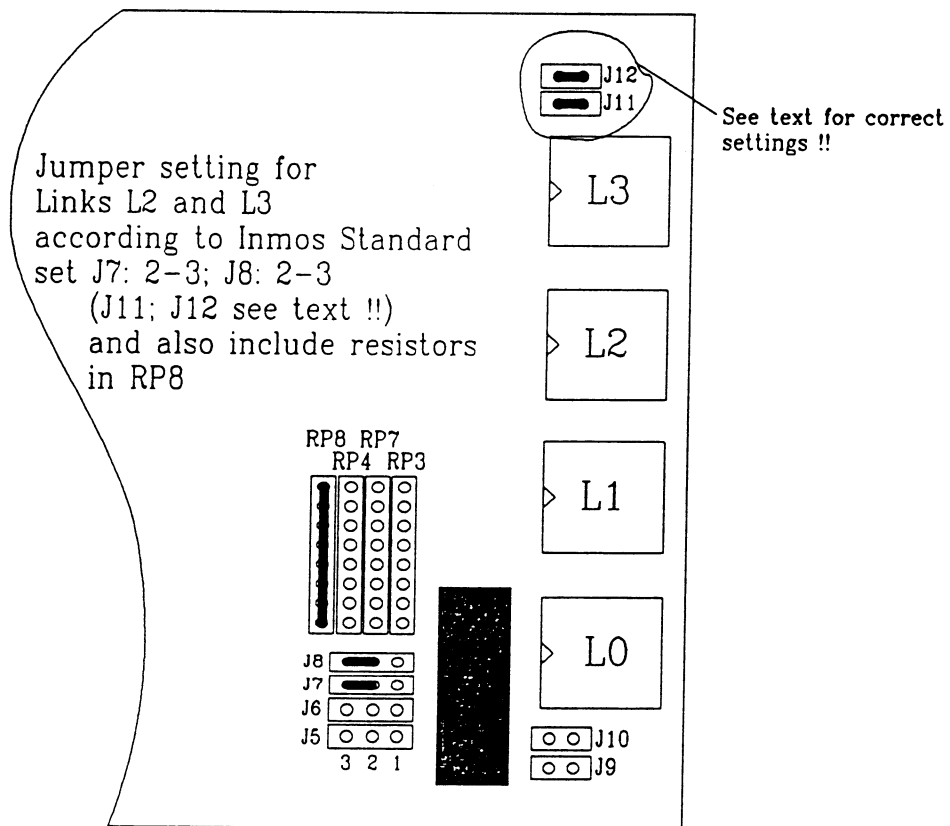

Fig 3.3.2.2 Inmos Link Standard for Links L2 and L3

**Note:** Before installing the board always verify Jumper settings. A misplaced jumper can possibly destroy the board !



### 3.4 Jumper Default Settings

For quick reference this small chapter contains all default settings.

**Check default settings when installing the board !**

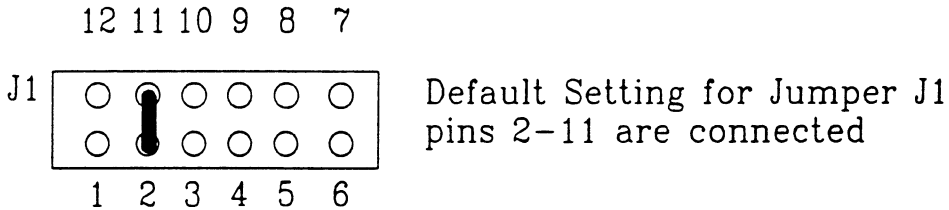

Fig 3.4.1 Default Setting Jumper J1

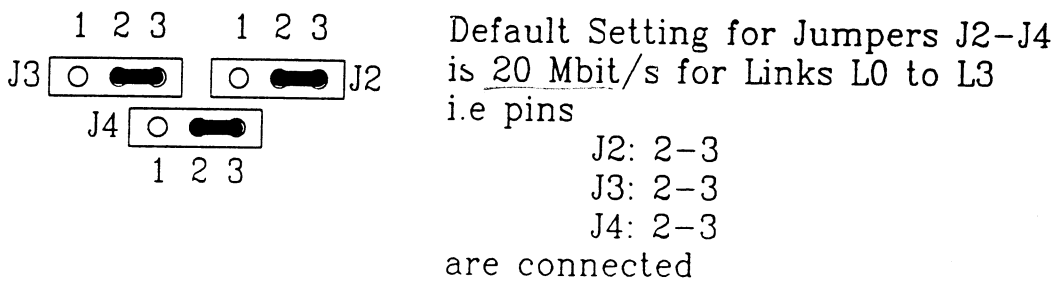

Fig 3.4.2 Default Setting Jumpers J2-J4

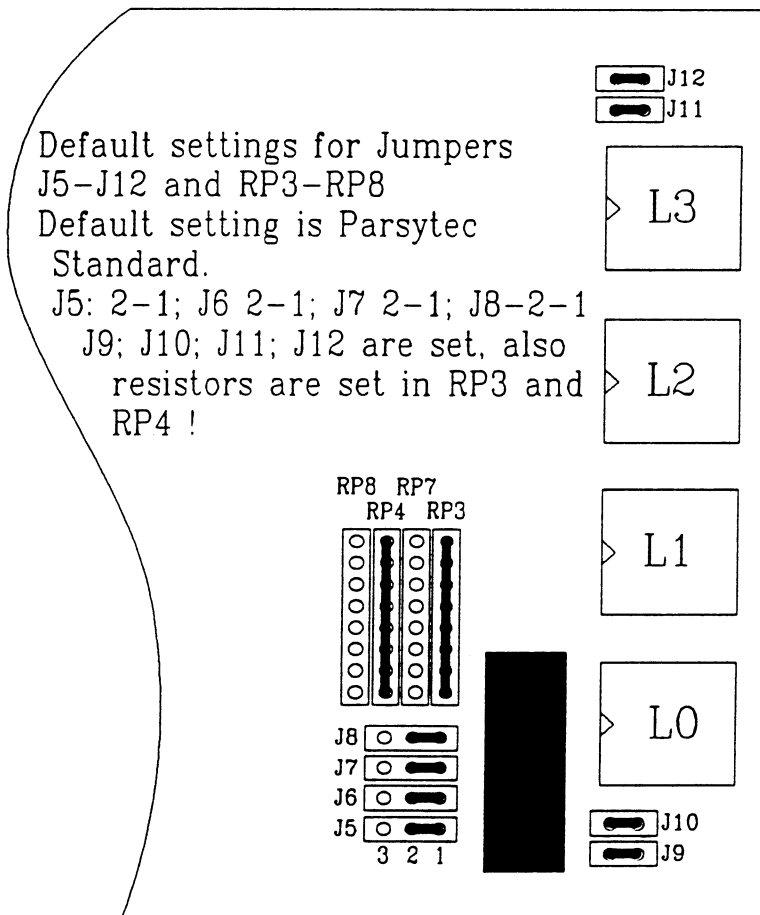

Fig 3.4.3 Default Setting Jumpers J5-J12 and Resistor Sockets

## 4. Memory configuration

The **BBK-S4** Adapter is equipped with 4 kByte SRAM memory, an Dual Ported Ram (DPR) area and -- for booting and protocol software -- uses a customized EPROM.

The four links L0 to L3 are the four T222 Transputer links

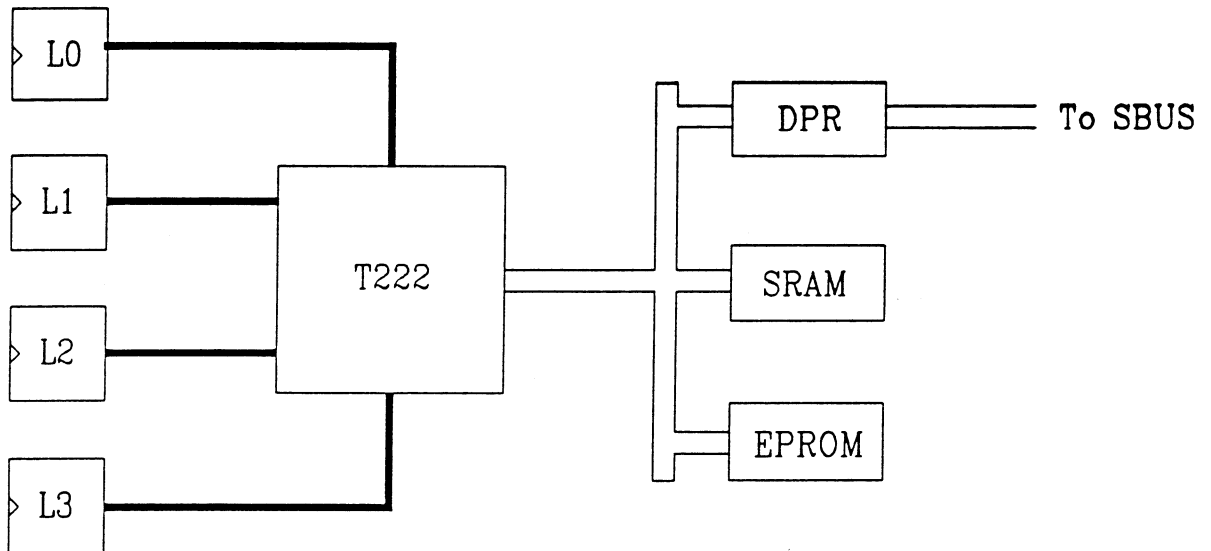

Fig. 4.1 Internal Memory Configuration

The following pages show the memory maps of the T222 transputer and the SBUS.(Figures 4.2., 4.3., 4.1.1. and 4.2.1. show the memory organization)

The SBUS and T222 have two Interrupt addresses that are part of the Dual Ported Ram (DPR). These Interrupts service the two directions of communication :

- A. T222 - SBUS direction (Address A)
- B. SBUS - T222 direction.(Address B)

Writing from T222 into A sets the Interrupt towards the SBUS and the SBUS reading from A resets the Interrupt.

The Interrupt in the other direction (SBUS - T222) is similar organized.

Writing from SBUS into B sets the Interrupt towards the T222 and the T222 reading from B resets the Interrupt.

One other important Register is the Reset Board Register on the SBUS side.

When writing the numbers 0, 1, 2, 3, 1 into the register consecutively the board is reset. Writing a 0 after this sequence will clear the Reset Board Register and the board is ready for booting.

The minimum reset time is 10 ms.

On the transputer side we have a Reset Out Register. Writing into this register will reset a specific link. To reset link L0 write 01hex, for L1 write 02hex for L2 write 04hex and finally writing 08hex resets L3. To clear this register again write 00hex. For minimum link reset time refer to the transputer manual.

Note that depending on the SBUS slot No. the Offset to be set in the basic developer's software changes. For this Offset and also the mapping that is performed on the SBUS side refer to the SBUS manual.

Finally the T222 CTR (Control Register) is shown in the map. For its use see the transputer manual.

T222 Memory Map

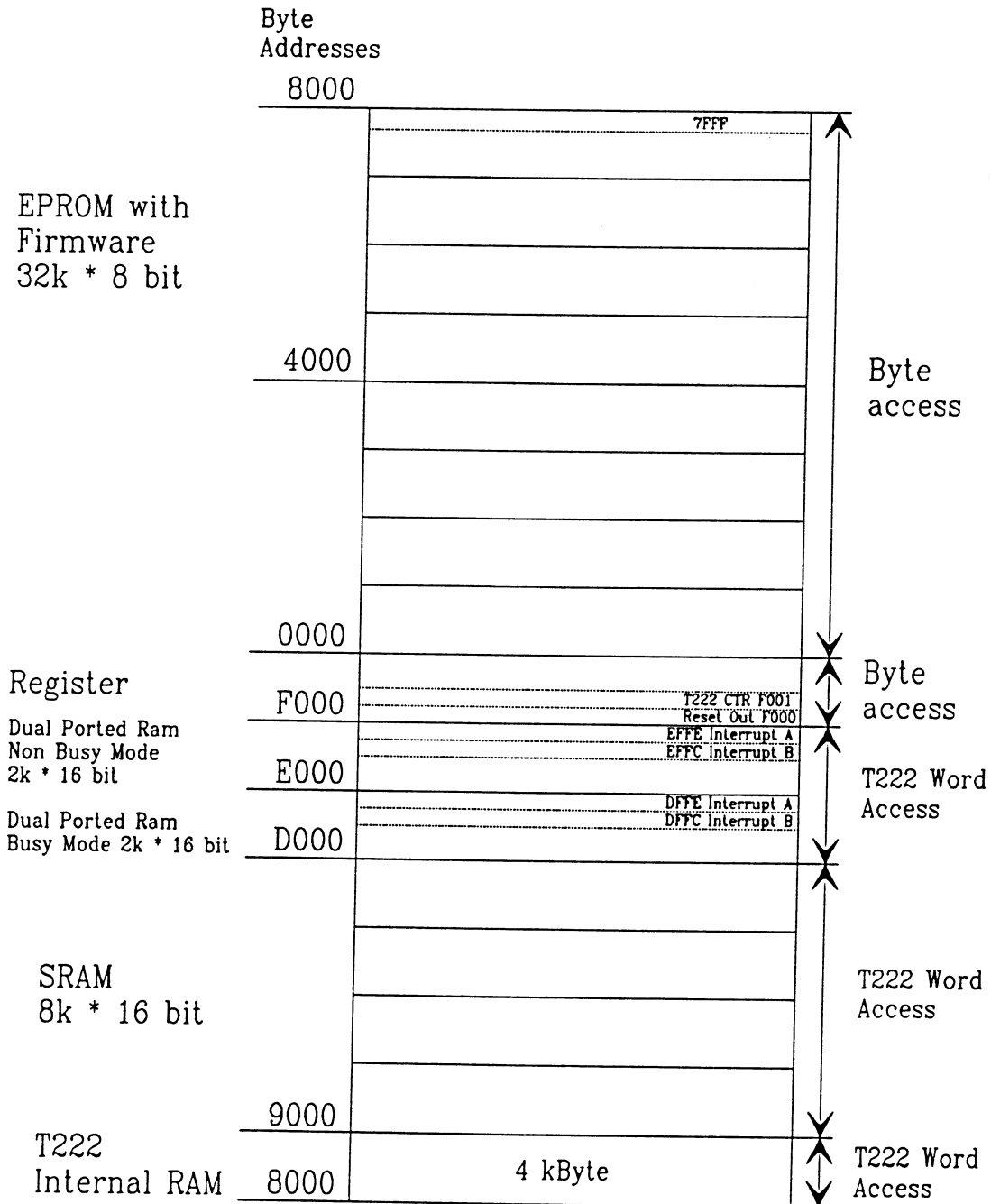

Fig. 4.2 T222 Memory Map

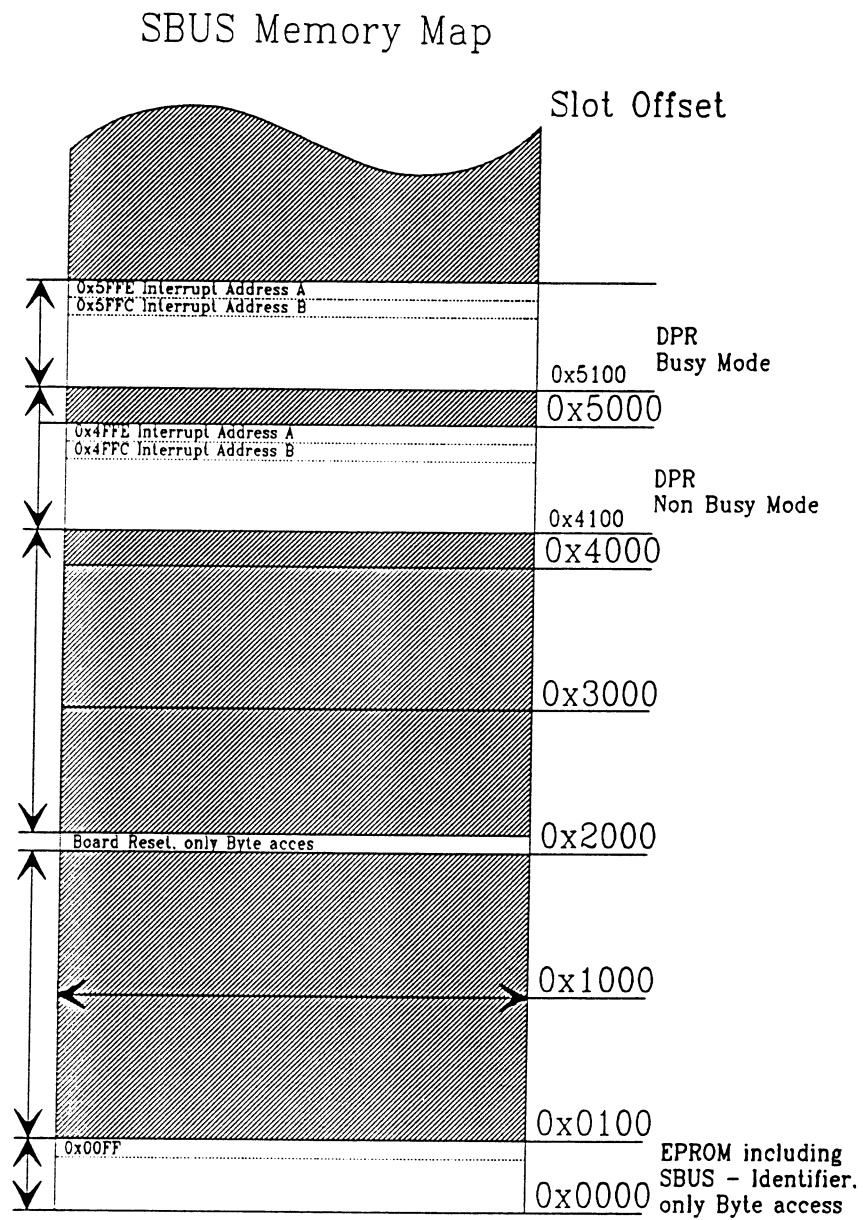

Fig. 4.3. SBUS Memory Map

## 4.1 The Dual Ported Ram

The **BBK-S4** Adapter uses a Dual Ported Ram (DPR) which is shared by the **SBUS**-server and the T222. The three top addresses (starting at 0xF80hex) are used to control the main communication needs. The top two addresses of the DPR are the Interrupt lines described above. All other addresses of the DPR are protocol dependent. The area below the interrupt lines, the Control Area (CA) controls all data streams on the bi-directional link channel, as e.g. reset, read No. of bytes, write No. of bytes... (see protocol description in chapter 4.2.). Fig 4.1.1. shows the address map of the DPR. The shipped software supports all **BBK-S4** Adapter functions. Also all basic developer's software tools run properly with the board. If, however, one needs direct access to link communication, the well tested and fast functions of **link.o** will suit these needs; also refer to chapter 3.3. Programming a BBK-S4 Link Protocol. The figure on the next page shows the DPR address map. Regard that depending on the address offset two different types of DPR access are possible :

Busy and Non Busy DPR access.

The selection for busy or non busy mode is software dependent.

In *busy mode* it is checked prior to accessing a single memory cell whether this cell is already being accessed. If this test shows the cell is free to be accessed, the read/write cycle is carried out. However, if a conflict occurs the process asking for the busy cell is halted until the cell is declared as non busy.

This mode should be used for all flags that are shared by the T222 and the **SBUS** (e.g. the communication line).

The *non busy* mode does not carry out this testing. One should however, take caution that at no time one cell can be accessed simultaneously ! However, does a simultaneous access occur the board will **not** be destroyed but the access might not be successful. Our basic software and the standard protocol use this mode for all data buffer since here one way communication is implemented (see standard protocol in chapter 4.2.) since the non busy mode is naturally faster than busy mode.

The DPR Address Map uses an memory area ranging from 100hex to FFFhex. To find the desired DPR area one has to add the respective offset either the SBUS Slot Offset and the Busy or Non Busy Mode Offset !

Example : For SBUS side the base addresses are 0x4100hex and 0x5100hex. The DPR in Busy Mode therefore starts at 0x5100hex.

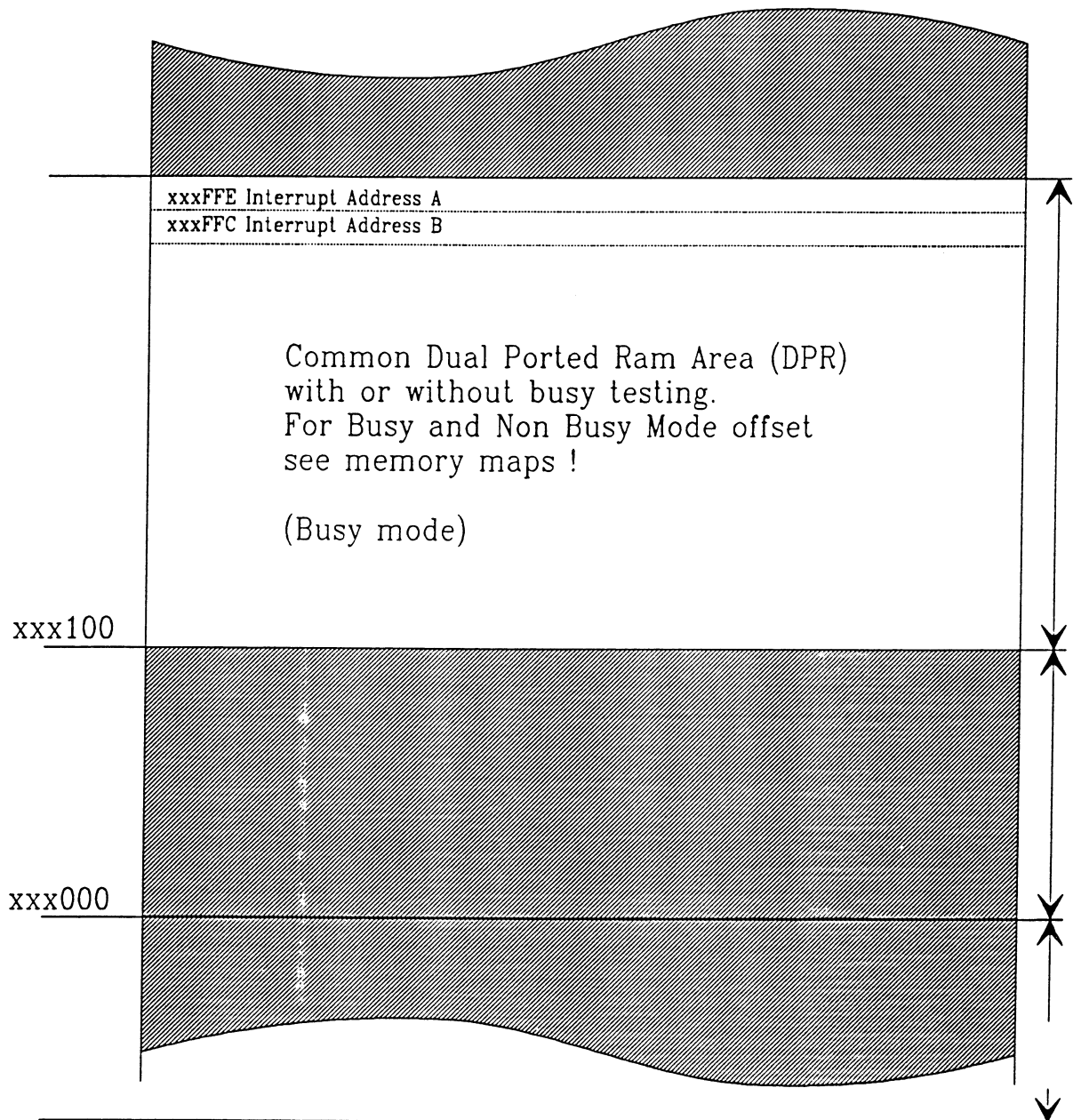

Fig. 4.1.1. Dual Ported Ram Address Map

### 4.2 The Standard BBK-S4 Protocol

The implemented protocol has the following memory map layout.

The CA of the DPR includes four 32 byte registers that control all communication regarding the four link buffer L0 to L3. The address offset depends on the slot No. of the host system and also depends on the mode selection desired (see chapter 4.1 Fig. 4.1.1.).

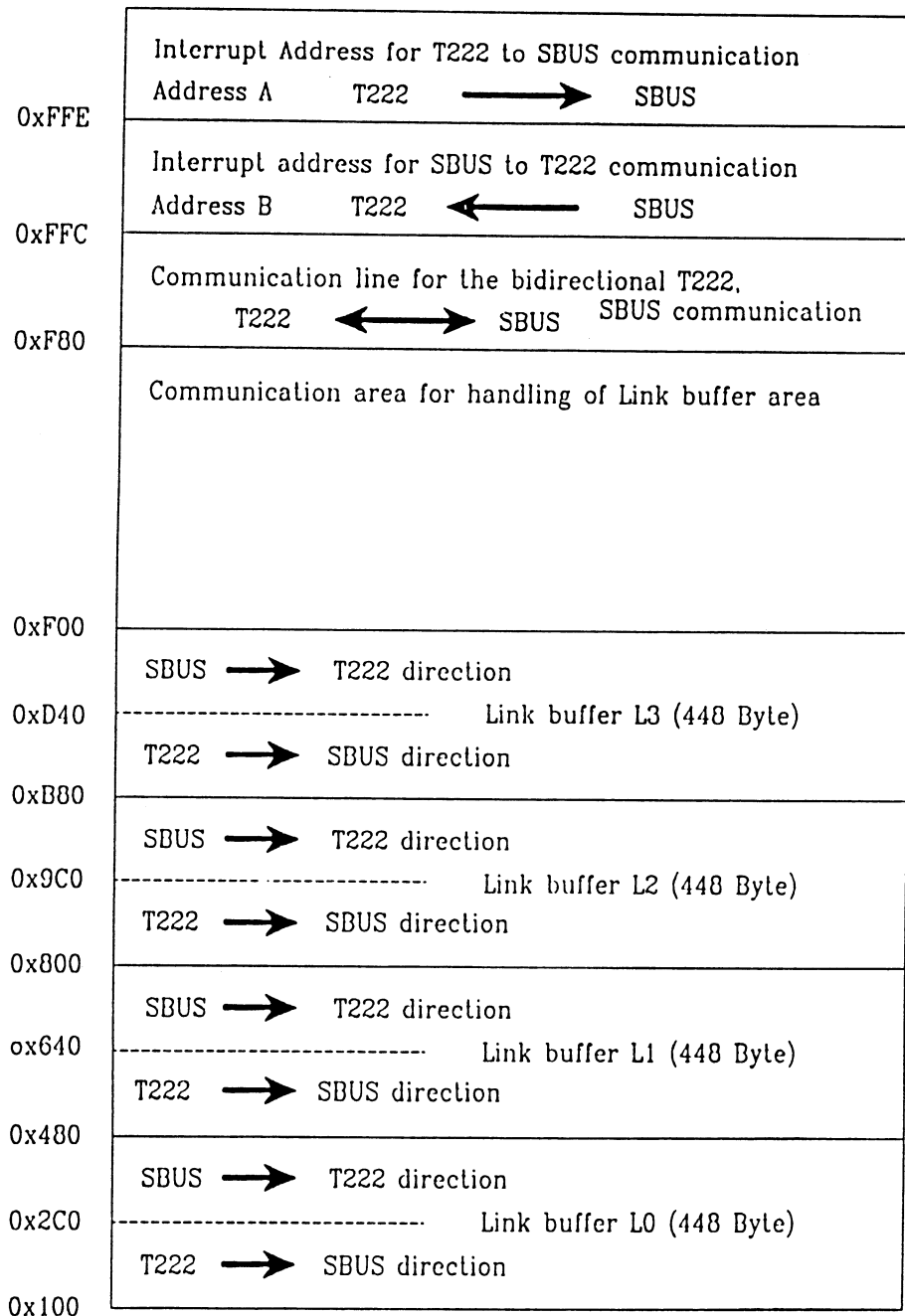

Fig. 4.2.1 DPR Memory Map for Standard Protocol

Each bi-directional link has a 448 Byte deep buffer, 224 Byte for each direction. The four registers handle the communication of those buffers separately and thus being very flexible.

This standard protocol has proved very flexible and reliable for almost every need. If, however, one wants to adapt the protocol to his special needs chapter 4.3 is a short guide to program such a protocol.



### 4.3 Programming a BBK-S4 Link Protocol

To write your own communication protocol e.g. just using two links in order to speed up over all performance, you must program your own bootable EPROM (Type (57) H256D-70). To program this EPROM use the Standard Transputer programming Software available (MultiTOOL<sup>1</sup>...). The EPROM must contain all firmware needed and the protocol as you desire. Above the memory maps are printed and a description of the DPR's function was given. For further information support will be offered.

---

<sup>1</sup> MultiTool is a registered Trademark of Parsytec, Aachen

---

### 5. Pin layout for the DIN connector and the link connectors

The **BBK-S4** Adapter uses two different types of connectors.

On the **SBUS** side the standard 96-pin DIN connector is used.

Table 5.1 shows the correct pin layout for the **BBK-S4** Adapter. Compare this layout with your system for compatibility.

Gnd	1	49	Clk
BR*	2	50	BG*
Sel*	3	51	AS*
IntReq(1)*	4	52	Gnd
D(00)	5	53	D(01)
D(02)	6	54	D(03)
D(04)	7	55	D(05)
IntReq(2)*	8	56	+5V
D(06)	9	57	D(07)
D(08)	10	58	D(09)
D(10)	11	59	D(11)
IntReq(3)*	12	60	Gnd
D(12)	13	61	D(13)
D(14)	14	62	D(15)
D(16)	15	63	D(17)
IntReq(4)*	16	64	+5V
D(19)	17	65	D(18)
D(21)	18	66	D(20)
D(23)	19	67	D(22)
IntReq(5)*	20	68	Gnd
D(25)	21	69	D(24)
D(27)	22	70	D(26)
D(29)	23	71	D(28)
IntReq(6)*	24	72	+5V
D(31)	25	73	D(30)
Siz(0)	26	74	Siz(1)
Siz(2)	27	75	Rd
IntReq(7)*	28	76	Gnd
PA(00)	29	77	PA(01)
PA(02)	30	78	PA(03)
PA(04)	31	79	PA(05)
LErr*	32	80	+5V
PA(06)	33	81	PA(07)
PA(08)	34	82	PA(09)
PA(10)	35	83	PA(11)
Ack(0)*	36	84	Gnd
PA(12)	37	85	PA(13)
PA(14)	38	86	PA(15)
PA(16)	39	87	PA(17)
Ack(1)*	40	88	+5V
PA(18)	41	89	PA(19)
PA(20)	42	90	PA(21)
PA(22)	43	91	PA(23)
Ack(2)*	44	92	Gnd
PA(24)	45	93	PA(25)
PA(26)	46	94	PA(27)
DtaPar	47	95	Reset*
-12V	48	96	+12V

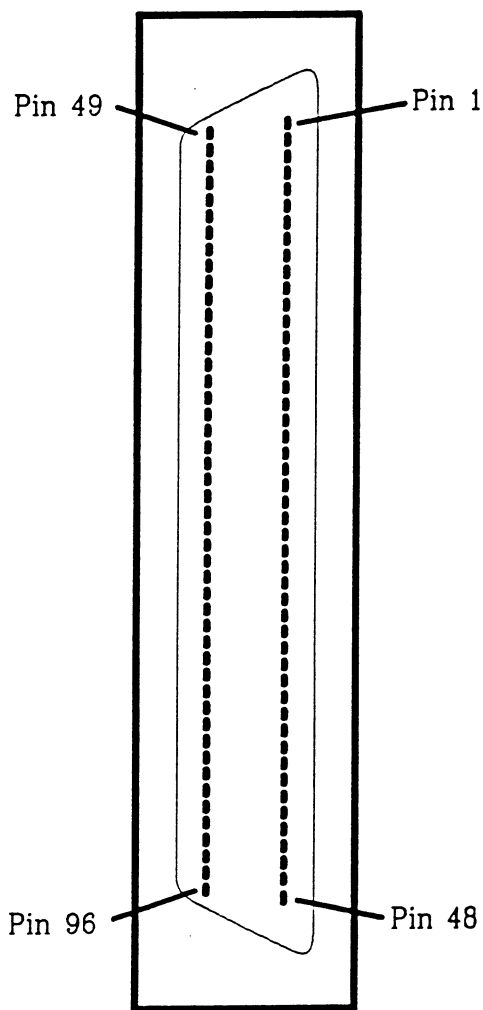

Tab. 5.1

Pin layout for **BBK-S4** Adapter on 96-pin DIN connector.

The four link connectors on the backplane of the adapter board use the following standard layout.

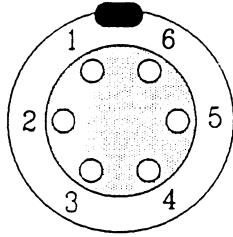

6 -pin Backplane Connector

frontview

Pin	Function Parsytec Standard	Inmos Standard
1	RESET-OUT +	RESET-OUT (RSO)
2	RESET-OUT -	Not RESET-OUT
3	LINK-OUT +	LINK-OUT (LO)
4	LINK-OUT -	Ground (GND)
5	LINK-IN -	Reserved (Do NOT connect)
6	LINK-IN +	LINK-IN (LI)

Tab 5.2 Pin layout for 6-pin link connector.

Use standard link cable only. For connection to 8-pin plugs or connectors secure that your cable follows the specifications as seen below.

8-pin plug		Cable	6-pin plug	
Pin No :	Function	Wire color	Pin No :	Function
1	Not connected			
2	Not connected			
3	Link Out +	gray	6	Link In +
4	Link Out -	pink	5	Link In -
5	Link In -	white	4	Link Out -
6	Link In +	brown	3	Link Out +
7	Reset In -	green	2	Reset Out -
8	Reset In +	yellow	1	Reset Out +

Tab 5.3 8-pin plug -- 6-pin connector cable specification.

Note that the Link In channel on the 6-pin side is connected to the Link Out Channel on the 8-pin side. (The normal 6-pin to 6-pin cable must also conform to this layout)

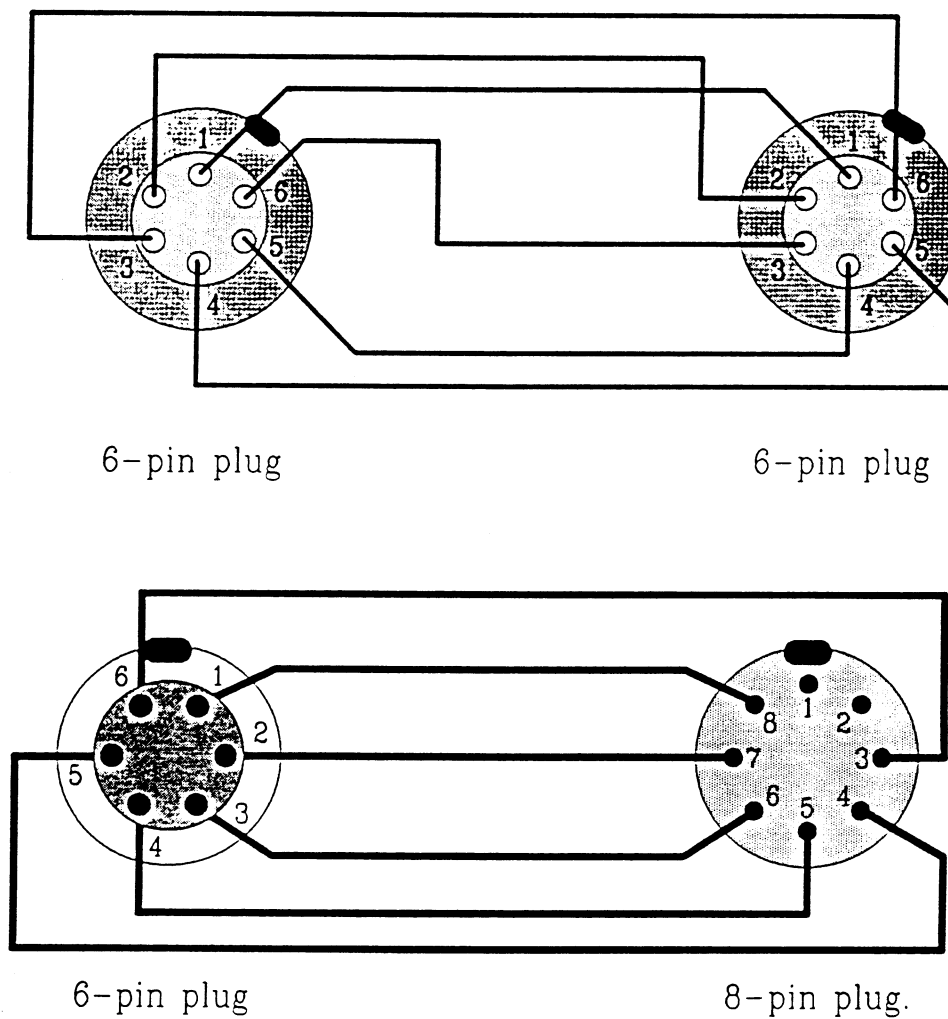

Fig. 5.1 Connector Layouts. Frontview !

Order List for plugs, connectors and cables

Standard Link Cable is available from Parsytec or Salespartners

To order the used connectors and plugs write to :

LEMOSA GmbH

Postfach 820529

W-8000 München 82

---

Fed. Rep. of Germany

For the 6-pin plug use Order code:

FGG. 1B 306. CLAD72

8-plug :

FGG. 1B 308 CNAD72

Cable type : 204 214

### 6. Technical Data

#### Power requirements

Voltage : 5 V +/- 0.4%  
 Current : 900 mA for standby  
 : 1500 mA for peak performance

EPROM : 2 x Type (57) H256D-70 Config + Firmware EPROM

The maximum data transfer rate for one link is : 880 kByte/s (using basic software)

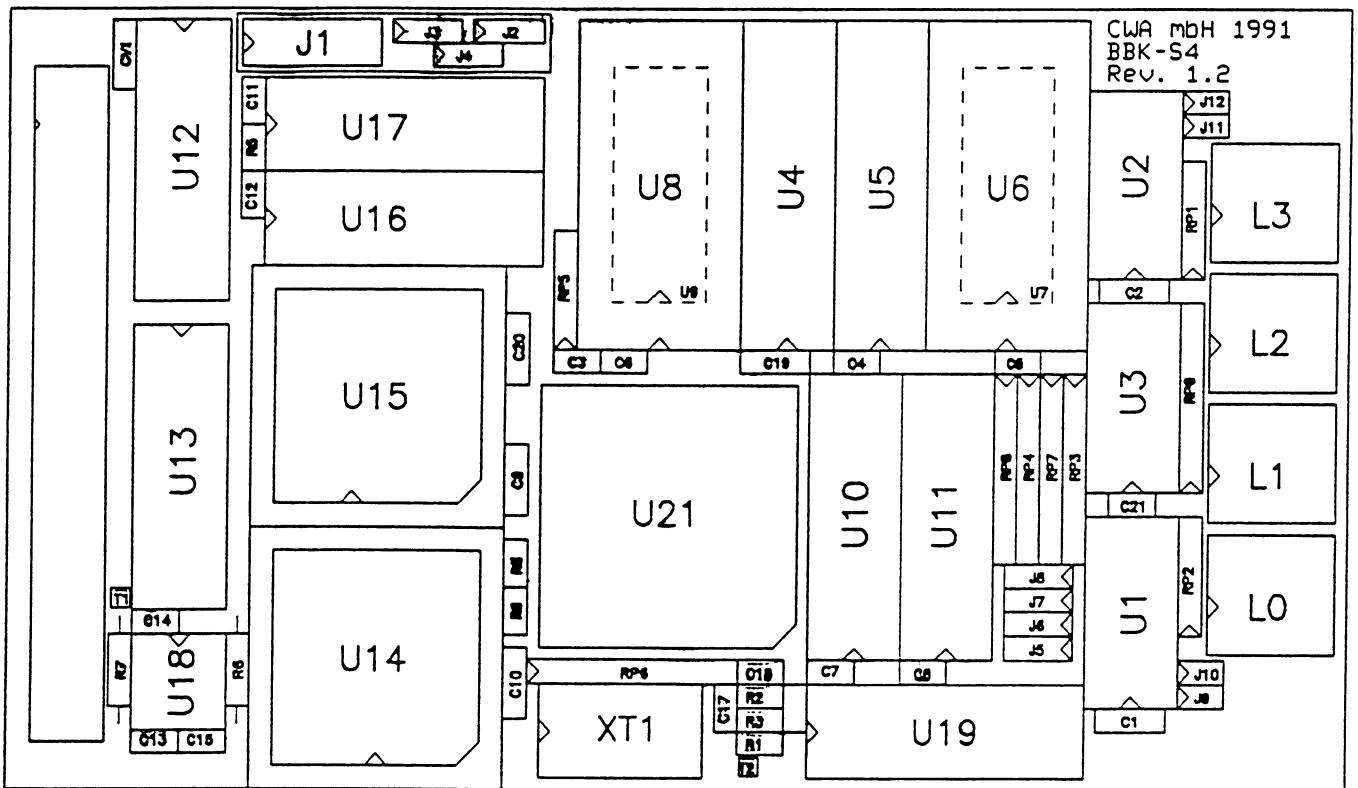

BBK-S4 Adapter Link Connector View

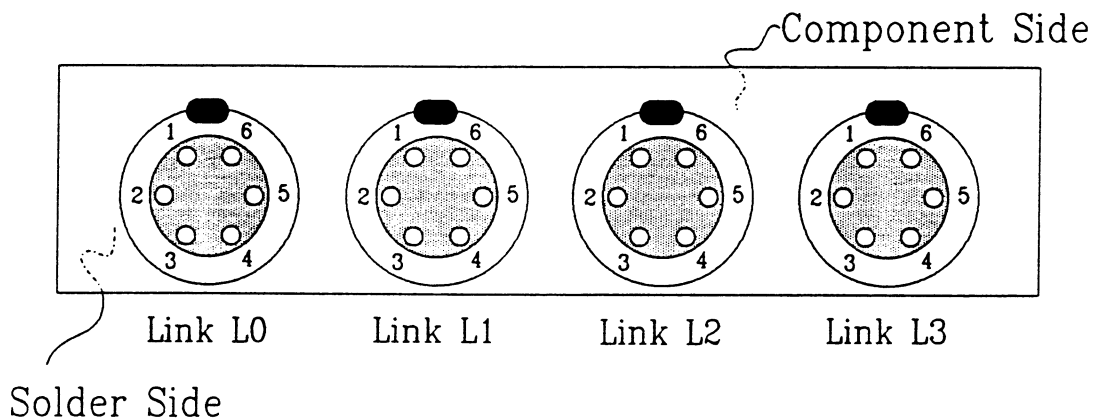

Fig. 6.1 Board overview: Top View; Backplane View

Component List

Item	Quantity	Reference	Component
1	2	RP3, RP4, RP7, RP8	Resistor Socket 4 * 220R (SIL 8) (simultaneously connect two only, see Jumper Settings chp. 3)
2	2	U1, U2	26 LS 31
3	1	U3	26 LS 32
4	2	U4, U5	stat. RAM TC 5588 P-25
5	2	U6, U8	EPROM TC 57H256D-70
6	1	U10	GAL 20V8-10
7	6	U11, U12, U13 U16, U17, U19	GAL 22V10-15
8	1	U14	Dual Ported RAM IDT 71421 SA-J
9	1	U15	Dual Ported RAM IDT 71321 SA-J
10	1	U18	Voltage watch 7705
11	1	U21	Transputer T222
12	2	CV1,C15	Security Capacitor 6.8 uF
13	19	C1,C2,C9,C10,C19,C20,C3,C4 C5,C6,C7,C8,C11,C12,C13,C14 C16,C17,C21	Block-Capacitor 100nF
14	1	C18	Tantalcapacitor 1 uF
15	1	J1	Modus-Jumper
16	3	J2,J3,J4	Jumper -- Link-Speed
17	4	J5,J6,J7,J8	Jumper -- Inmos/Parsytec-Umsch.
18	4	J9,J10,J11,J12	Jumper -- Series Resistor in Link (if set Series resistor is shorted)
19	4	L1,L2,L3,L4	Lemosa-Connector 6-pin.
20	6	R1,R2,R3,R5,R8,R9	Resistor 33 Ohm
21	1	R6	Resistor 470 Ohm
22	1	R7	Resistor 100 Ohm
23	2	RP1, RP2	Resistor Socket 4 * 1K, SIL5
24	1	RP5	Resistor Socket 4 * 4K7, SIL5
25	1	RP6	Resistor Socket 8 * 4K7, SIL9
26	1	RP9	Resistor Socket 4 * 100 Ohm, SIL8
27	2	T1, T2	Testpin
28	2	U7, U9	74 FCT 244
29	1	XT1	Quarz-Oszillator 5MHz